

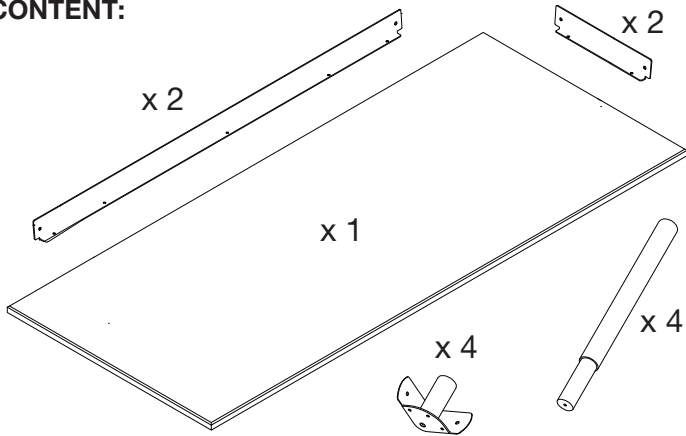







# ASSEMBLY INSTRUCTION

## ADAPTABLE BY TAF ARCHITECTS

**CONTENT:**



- |   |   |      |   |   |     |
|---|---|------|---|---|-----|
| A |  | x 4  | E |  | x 8 |
| B |  | x 1  | F |  | x 8 |
| C |  | x 26 | G |  | x 1 |
| D |  | x 24 |   |   |     |

