

RS 220

Digital wireless
system



Instruction manual

 **SENNHEISER**

Contents

- Important safety information 2
- The RS 220 digital RF headphone system 4
- Delivery includes 5
- Product overview 6
 - Overview of the headphones 6
 - Overview of the transmitter 7
 - Overview of the transmitter’s connections 7
 - Overview of the indicators 8
- Putting the RS 220 into operation 9
 - Setting up the transmitter 9
 - Connecting the transmitter to audio sources 10
 - Connecting the transmitter to the mains 14
 - Charging the rechargeable batteries inside the headphones 14
 - Adjusting the headband of the headphones 15
- Using the RS 220 16
 - Switching the transmitter on/off 16
 - Switching the headphones on/off 19
 - Selecting an audio source or toggling between audio sources 21
 - Adjusting the volume on the headphones 23
 - Adjusting the balance 23
 - Associating a second pair of headphones to the transmitter 24
- Cleaning and maintaining the RS 220 25
 - Changing the rechargeable batteries of the headphones 25
 - Replacing the ear pads 26
- If a problem occurs 27
- Specifications 29
- Manufacturer declarations 30



Important safety information

- ▶ Please read this instruction manual carefully and completely before using the product.
- ▶ Make this instruction manual easily accessible to all users at all times. Always include this instruction manual when passing the product on to third parties.
- ▶ This instruction manual is also available on the Internet at www.sennheiser.com.

Preventing health problems

- ▶ Before using the product, set the volume to a low level. To protect your hearing, avoid listening at high volume levels for long periods of time.
- ▶ Do not use the product in situations which require special attention (e.g. in traffic or when performing skilled jobs).

The product generates stronger permanent magnetic fields that could cause interference with cardiac pacemakers and implanted defibrillators (ICDs).

- ▶ Always maintain a distance of at least 3.94" (10 cm) between the ear piece housing and the cardiac pacemaker or implanted defibrillator.

Preventing damage to the product

- ▶ Always keep the product dry and do not expose it to extreme temperatures (normal operating temperatures: 5°C/41°F to 40°C/104°F).
- ▶ Use the product with care and store it in a clean, dust-free environment. Varnish or furniture polish may degrade the feet of the transmitter, which could stain your furniture. You should therefore place the transmitter on a non-slip pad to avoid potential staining of furniture.
- ▶ Switch the headphones off after use to conserve battery power. Remove the batteries if the headphones will not be used for extended periods of time.

Preventing damage to the power supply unit

- ▶ To reduce the risk of fire or electric shock, do not expose the product to rain or moisture.
- ▶ Unplug the mains unit from the wall socket to completely disconnect the product from the mains, during lightning storms or when unused for long periods of time.
- ▶ Only operate the mains unit from the type of power source specified in the chapter "Specifications".
- ▶ To prevent heat accumulation, always ensure that the mains unit is in a safe operating condition and easily accessible, properly plugged into the wall socket and not covered or exposed to direct sunlight for longer periods of time.
- ▶ Only use the power supply units, charging cables and accessories recommended by Sennheiser. An overview can be found on www.sennheiser.com.

Intended use

Intended use of the product includes

- having read this instruction manual, especially the chapter “Important safety information”,
- using the product within the operating conditions and limitations described in this instruction manual.

“Improper use” means using the product other than as described in this instruction manual, or under operating conditions which differ from those described herein.















Safety instructions for the NiMH rechargeable batteries

If abused or misused, the rechargeable batteries may leak. In extreme cases, they may even present



- a heat hazard,
- a fire hazard,
- an explosion hazard,
- a smoke or gas hazard.

Please understand that Sennheiser does not accept liability for damage arising from abuse or misuse.

	Keep away from children.		Only charge the rechargeable batteries in the headphones (see page 14).
	Observe correct polarity.		Pack/store charged batteries so that the terminals cannot contact each other – danger of shorting out/fire hazard.
	Do not expose to moisture.		Switch rechargeable battery-powered products off after use.
	Only charge rechargeable batteries at ambient temperatures between 10°C/50°F and 40°C/104°F.		When not using rechargeable batteries for extended periods of time, charge them regularly (about every 3 months).
	Do not mutilate or dismantle.		Do not heat above 70°C/158°F, e.g. do not expose to sunlight or throw into a fire.
	Immediately remove rechargeable batteries from an obviously defective product.		Do not continue to use defective rechargeable batteries.
	Only use rechargeable batteries specified by Sennheiser.		Dispose of rechargeable batteries at special collection points or return it to your specialist dealer.

The RS 220 digital RF headphone system

Experience audiophile sound quality with the RS 220 digital wireless headphone system. Consisting of a transmitter and open, circum-aural headphones, the system offers uncompressed music enjoyment – just like wired high-end headphones.

The rechargeable batteries can conveniently be recharged while in the headphones. Enjoy total freedom of sound, stylish design and maximum comfort.

Additional features of the RS 220 RF headphone system

- Transmits uncompressed CD-quality audio over a robust 2.4 GHz digital link, enabling you to enjoy your music without the hassles of cables.
- Dynamic transducer systems with powerful neodymium magnets deliver clear and detailed audio reproduction.
- No set-up required – just plug and play. Simply connect the transmitter to your personal audio/video player, put on the headphones and turn it on.
- Up to four persons can listen simultaneously with optional headphones and a single TR 220 transmitter.
- Signals can be looped through so that the transmitter can be integrated into an existing connection between 2 devices
- Universal connections:
 - 1 analog input and output
 - 1 coaxial digital input and output
 - 1 optical digital input and output



Delivery includes



HDR 220 headphones



TR 220 transmitter

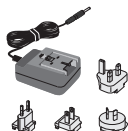

Power supply unit with country adapters



Stereo audio cable with dual RCA plugs on each end



Coaxial cable with a single RCA plug on each end – for digital connections



Audio adapter
(3.5 mm jack plug to 2 RCA sockets)

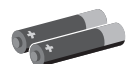

Rechargeable batteries, HR03, AAA size, NiMH



Quick Guide incl. CD ROM
with detailed instruction manual (PDF file)



Safety Guide



A list of accessories can be found on the RS 220 product page at www.sennheiser.com. For information on suppliers, contact your local Sennheiser partner: www.sennheiser.com > "Service & Support".

Product overview

Overview of the headphones



- ① Headband
- ② Charging contacts
- ③ Battery compartments
- ④ Ear pads
- ⑤ Volume +/L button
- ⑥ Balance button for changing between Volume/Balance
- ⑦ Volume -/R button
- ⑧ On/Off button
- ⑨ Power LED
- ⑩ Input button for selecting the audio source

Overview of the transmitter

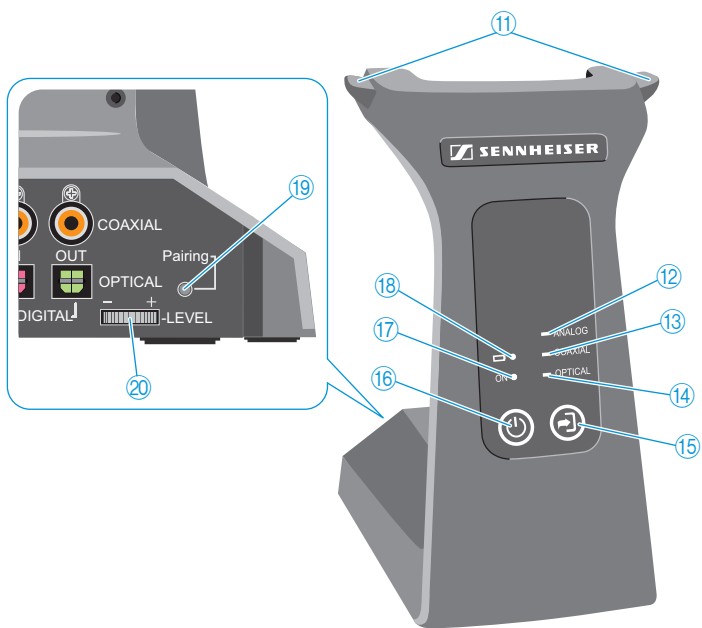

- 11 Charging contacts for charging the headphones
- 12 ANALOG LED
- 13 COAXIAL LED
- 14 OPTICAL LED
- 15 Touch key for selecting the audio source
- 16 Power touch key
- 17 ON LED
- 18 Battery LED
- 19 Pairing button
- 20 LEVEL control dial

Overview of the transmitter's connections

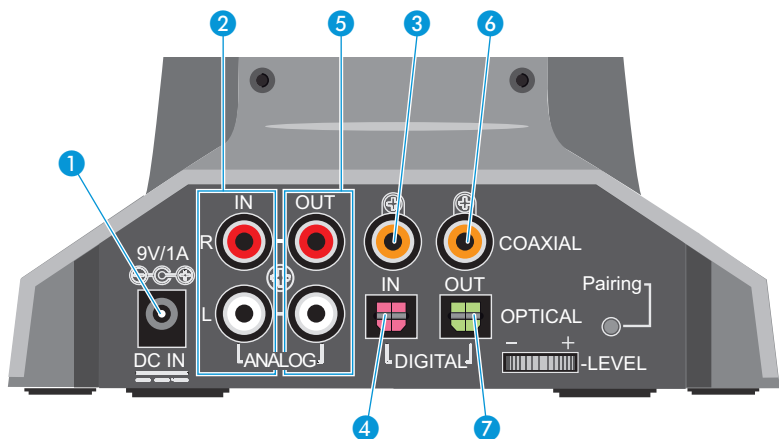

- 1 DC IN socket for power supply unit

Inputs

- 2 ANALOG IN (analog)
- 3 COAXIAL IN (digital coaxial)
- 4 OPTICAL IN (digital optical)

Outputs

- 5 ANALOG OUT (analog)
- 6 COAXIAL OUT (digital coaxial)
- 7 OPTICAL OUT (digital optical)

Overview of the indicators

Indicators on the headphones

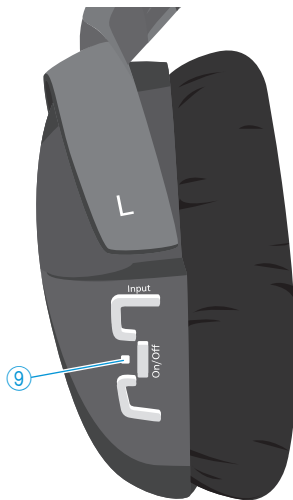

Indicator	Status	Meaning
Power LED ⑨	lights up blue	The headphones have found a suitable transmitter.
	flashes blue	The headphones haven't found a suitable transmitter.
	flashes alternately blue and red	The headphones are in pairing mode.
	flashes red	The rechargeable batteries are almost flat.
	off	The headphones are switched off.

Indicators on the transmitter

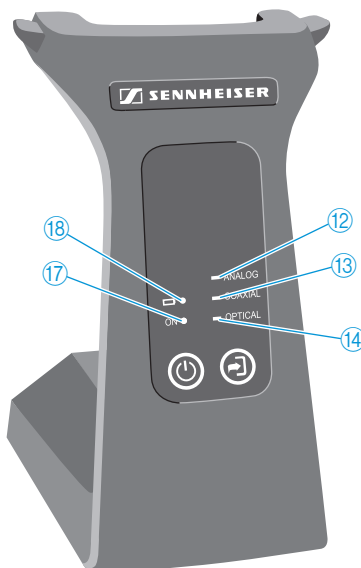

Indicator	Status	Meaning
ON LED ⑰	lights up green	The transmitter has found suitable headphones.
	flashes green	The transmitter hasn't found suitable headphones.
	lights up red	The transmitter is in loop through mode (i.e. a digital signal can be looped through to connected devices).
	off	The transmitter is in standby mode.
Battery LED ⑱	lights up red	The rechargeable batteries are being charged.
	off	The rechargeable batteries are fully charged.
ANALOG LED ⑫ / COAXIAL LED ⑬ / OPTICAL LED ⑭	lights up green	The corresponding input ("IN") has been selected.

Putting the RS 220 into operation

Setting up the transmitter

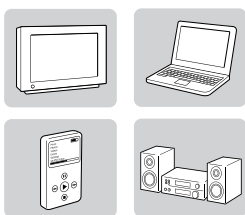

- ▶ Choose a suitable place near your audio source (e.g. TV, stereo or home cinema system). Avoid placing the transmitter close to metal objects such as shelf bars, reinforced concrete walls, etc. as this can decrease the transmitter's range.





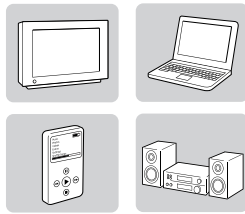

- i** It is not necessary that the transmitter and headphones are in the same room, so you can move around freely in the home or outside in the garden.

Connecting the transmitter to audio sources



You can connect up to 3 audio sources (e.g. CD player, DVD player and TV) to the transmitter. The transmitter is fitted with 2 digital and 1 analog inputs and outputs. If you connect several audio sources, you can conveniently toggle between these audio sources with a key press (see page 21).

- ▶ Switch your audio source off before connecting the transmitter.
- ▶ Check the available connection possibilities of your audio source.
- ▶ Select the corresponding connection cable and, if necessary, a suitable adapter.

Connection possibilities (output) of the audio source		Connection cable/adapter
A	RCA (analog)	 Stereo audio cable with dual RCA plugs on each end
B	SCART (analog)	 Stereo audio cable with audio adapter (to be ordered separately)
C	Headphone socket (analog)	 Stereo audio cable with audio adapter
D	Coaxial (digital)	 Coaxial cable with a single RCA plug on each end
E	Optical (digital)	 Optical digital cable (to be ordered separately)

- ▶ Follow the instructions in the corresponding chapter in order to connect your transmitter to the audio source.

A Connecting the transmitter to RCA sockets

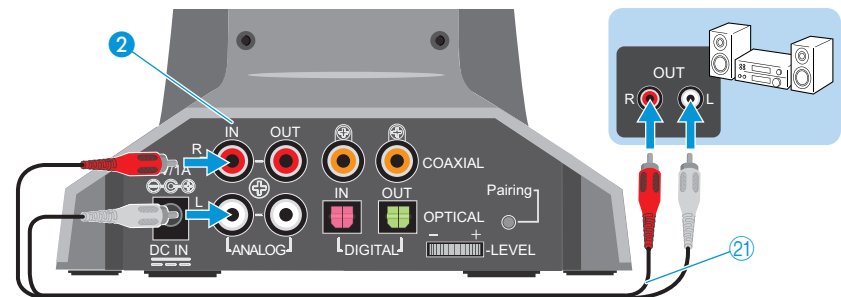

- ▶ Connect the RCA plugs of the stereo audio cable ② to the corresponding RCA sockets of your audio source.
- ▶ Connect the RCA plugs of the stereo audio cable ② to the left ("L") and right ("R") ANALOG IN input ②.

B Connecting the transmitter to a SCART socket

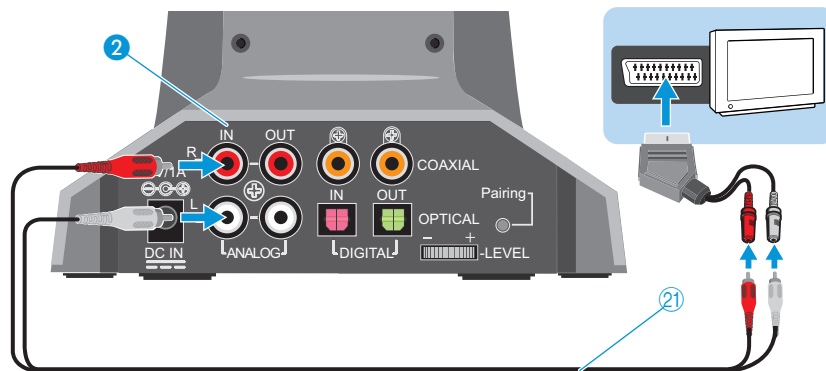

- ▶ Connect the RCA plugs of the stereo audio cable ②1 to the corresponding RCA sockets of the SCART adapter.
- ▶ Connect the SCART adapter to the SCART socket of your audio source.
- ▶ Connect the RCA plugs of the stereo audio cable ②1 to the left ("L") and right ("R") ANALOG IN input ②.

i A suitable SCART adapter is available from your specialist dealer.

C Connecting the transmitter to a headphone socket

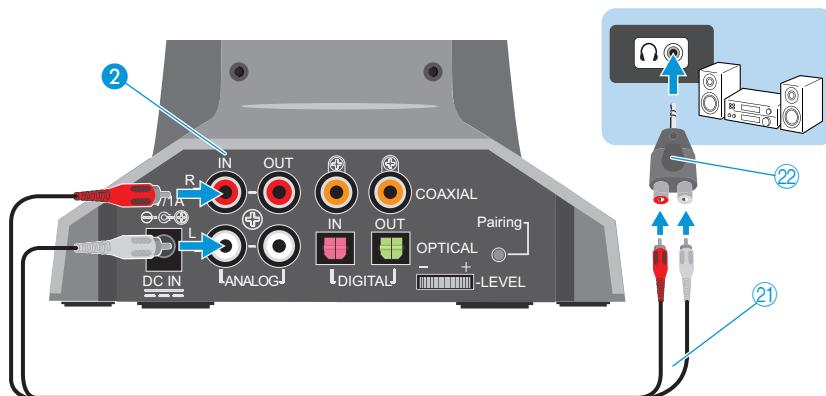

- ▶ Connect the RCA plugs of the stereo audio cable ②1 to the corresponding RCA sockets of the audio adapter ②2.
- ▶ Connect the audio adapter ②2 to the headphone socket of your audio source.
- ▶ Connect the RCA plugs of the stereo audio cable ②1 to the left ("L") and right ("R") ANALOG IN input ②.

D Connecting the transmitter to a coaxial digital output

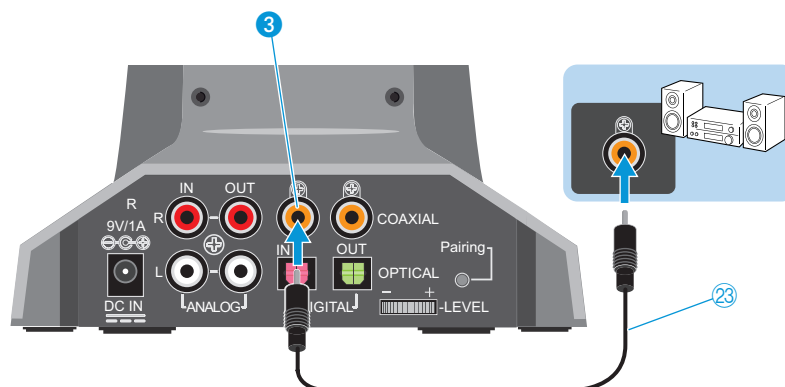

- ▶ Connect the RCA plug of the coaxial cable 23 to the RCA socket (digital output) of your audio source.
- ▶ Connect the RCA plug of the coaxial cable 23 to the COAXIAL IN input 3.

E Connecting the transmitter to an optical digital output

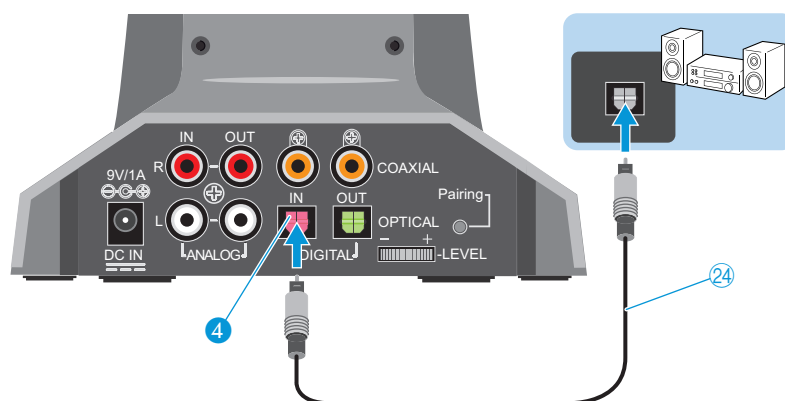

- ▶ Connect the connector of the optical digital cable 24 to an optical digital output of your audio source.
- ▶ Connect the connector of the optical digital cable 24 to the OPTICAL IN input 4.

i A suitable optical cable is available from your specialist dealer.

Integrating the transmitter into an existing connection between devices

You can integrate the transmitter into an existing connection between your audio source and an additional device. By way of example of an amplifier as an additional device, this chapter describes how to integrate the transmitter into an existing connection.

- ▶ Pull out the plug of the audio cable from the desired input ("IN") on the amplifier.

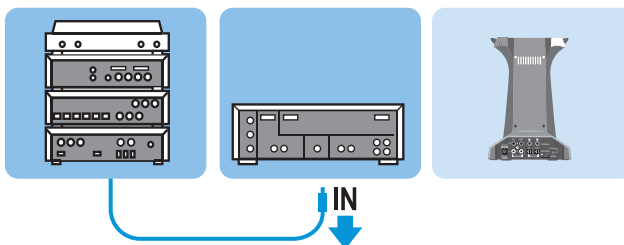

- ▶ Connect this plug to a suitable input ("IN") on the transmitter (see page 7).

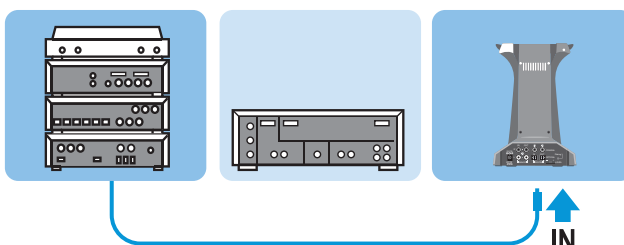

- ▶ Connect an additional identical audio cable to the output ("OUT") on the transmitter and to the input ("IN") on the amplifier.

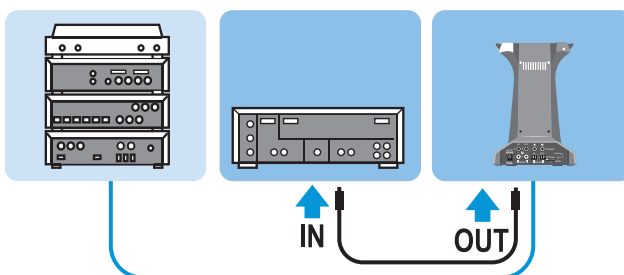

To keep the digital connection up even when the transmitter is switched off:

- ▶ Switch the loop through mode on (see page 17).

i The **analog connection** (RCA/SCART/headphone socket) is kept up when you disconnect the transmitter from the mains. The **digital connection** (coaxial/optical) is interrupted in this case.

Connecting the transmitter to the mains

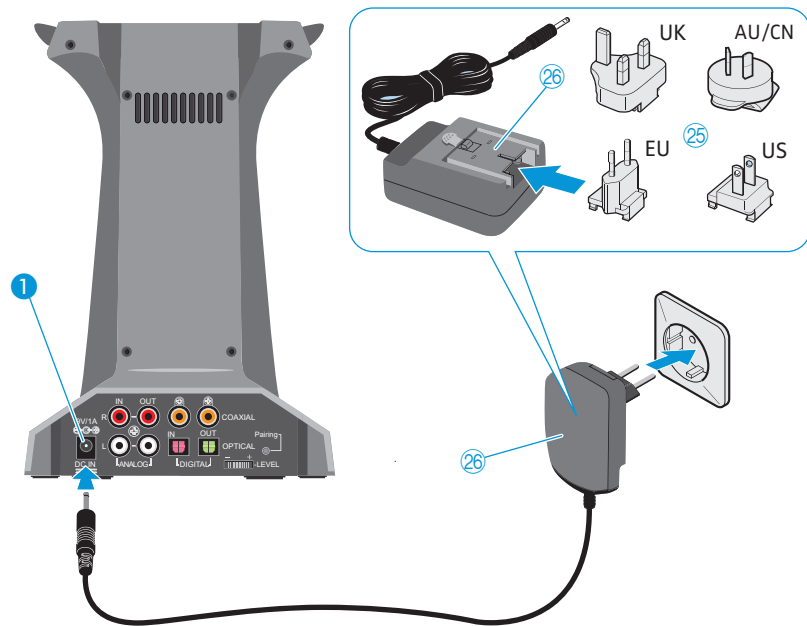

- ▶ Select a suitable country adapter **25** for your wall socket.
- ▶ Slide the country adapter **25** onto the power supply unit **26** until it locks into place.
- ▶ Connect the connector of the power supply unit to the socket **1**.
- ▶ Plug the power supply unit **26** into a wall socket.
The transmitter switches on. The **ON LED 17** and the **COAXIAL LED 13** light up green.

Charging the rechargeable batteries inside the headphones

Before using the headphones for the first time, remove the protection strip from the rechargeable batteries and charge the rechargeable batteries for optimum operation.

Removing the protection strip

- ▶ Tilt the ear cup slightly inwards.
- ▶ Open the battery compartment **3** on the ear cup using your finger nail.
- ▶ Pull the protection strip from the battery compartment.

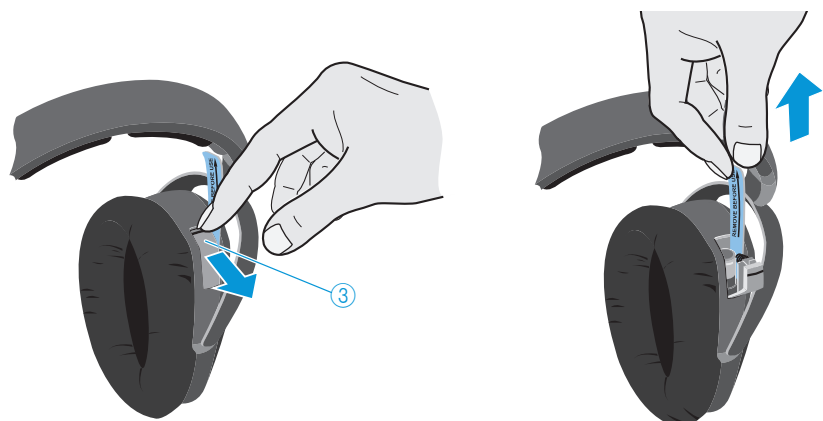

Charging the rechargeable batteries inside the headphones



Charge the rechargeable batteries for at least 16 hours prior to first time use. The operating time is up to 8 hours.



- ▶ Place the headphones on the charging contacts ⑪ of the transmitter. The rechargeable batteries are being charged. The Battery LED ⑱ lights up red.

When the rechargeable batteries are fully charged, the Battery LED ⑱ goes off.

i Always store the headphones on the headphone holder to ensure that they are fully charged when they are needed. The battery charging technology prevents over-charging.

Adjusting the headband of the headphones

For good sound quality and best possible comfort, the headband has to be adjusted to properly fit your head. To do so, adjust the headband ① via its snap-in locking mechanism:



- ▶ Wear the headphones so that the headband ① runs over the top of your head.
- ▶ Adjust the length of the headband so that
 - your ears are completely inside the earpads,
 - you feel even, gentle pressure around your ears,
 - a snug fit of the headband ① on the head is ensured.

Using the RS 220

To switch the product on and to listen to your audio source, proceed as follows:

Sequence of steps	Page
1. Make sure that the rechargeable batteries are charged.	14
2. Switch your audio source on.	–
3. Switch your transmitter on.	16
4. Switch your headphones on.	19
5. Select the desired audio source.	21
6. Put on the headphones.	15
7. Adjust the desired volume on the headphones.	23

Switching the transmitter on/off

Switching the transmitter on

- ▶ Touch the **Power** touch key **16**.
The transmitter switches on. The LED of the last selected audio source (here **COAXIAL**) lights up. The **ON** LED **17** flashes until the transmitter has found suitable headphones and then lights up continuously.



- i** If the transmitter doesn't receive an audio signal for more than 3 minutes, it switches, depending on the setting, to either standby mode or loop through mode. If the transmitter receives an audio signal within the next 10 minutes, it automatically switches on again.

Switching the loop through mode on/off

In loop through mode, the signals are looped through from one device to another, even when the transmitter is switched off.

To switch the loop through mode **on**:

- ▶ Touch the touch key for selecting the audio source ⑮ on the transmitter until the ANALOG LED ⑫, the COAXIAL LED ⑬ and the OPTICAL LED ⑭ light up green simultaneously for a moment.
- ▶ Switch the transmitter off. The ON LED ⑰ lights up red, the transmitter is in loop through mode.

To switch the loop through mode **off**:

- ▶ Touch the touch key for selecting the audio source ⑮ on the transmitter again until the ANALOG LED ⑫, the COAXIAL LED ⑬ and the OPTICAL LED ⑭ light up green simultaneously.
- ▶ Switch the transmitter off. The ON LED ⑰ is **off**, the transmitter is in standby mode.

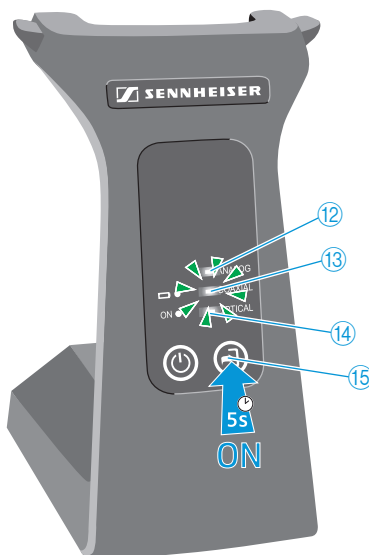

Switching the transmitter off

- ▶ Briefly touch the **Power** touch key ⑯.
All LEDs go off. The transmitter is
 - in **standby mode** when the **ON LED ⑰** is off or
 - in **loop through mode** when the **ON LED ⑰** lights up red.

When the transmitter is switched on the next time, it selects the last set input.



To disconnect the transmitter from the mains:

- ▶ Pull out the mains plug from the wall socket.
The transmitter is reset to the factory default settings. Please note that in this case, the headphones' rechargeable batteries will not be recharged.

Switching the headphones on/off



WARNING

Danger of hearing damage!

Listening at high volume levels for long periods can lead to permanent hearing defects.

- ▶ Before putting the headphones on, set the volume to a low level.
- ▶ Do not continuously expose yourself to high volumes.



WARNING

Interferences due to magnetic fields!

The product generates stronger permanent magnetic fields that could cause interference with cardiac pacemakers and implanted defibrillators (ICDs).

- ▶ Always maintain a distance of at least 3.94" (10 cm) between the ear cup housing and the cardiac pacemaker or implanted defibrillator.

Switching the headphones on

- ▶ Press the **On/Off** button ⑧ until the **Power LED** ⑨ lights up blue or flashes.

The headphones switch on and search for a suitable transmitter. Once the headphones have found a suitable transmitter, the transmitter connects with the headphones and transmits the audio signal of the selected input. The **Power LED** ⑨ lights up continuously.



Switching the headphones off

- ▶ Press and hold the On/Off button ⑧ until the Power LED ⑨ goes off. The headphones switch off.



- i** If there is no audio signal from the transmitter for more than 10 minutes, the headphones automatically switch off.

Selecting an audio source or toggling between audio sources

You can connect different audio sources to the transmitter. Once you have connected **an audio source**, you then have to select the audio source.

If you have connected **different audio sources** to the transmitter, you can toggle between the audio sources:

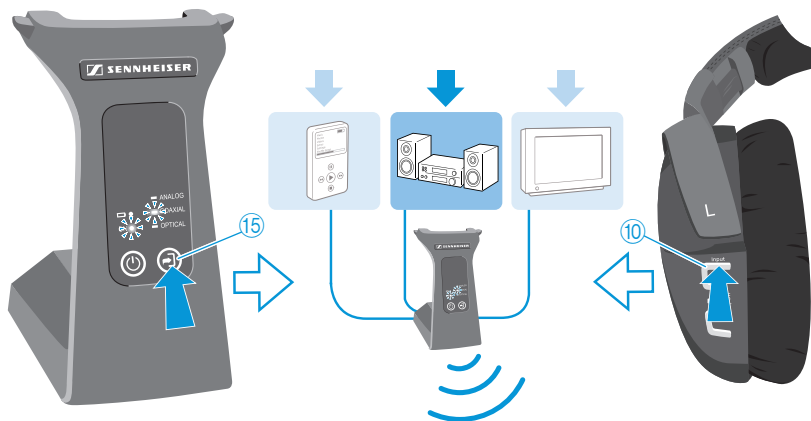

► Touch the touch key for selecting the audio source 15 on the transmitter or press the **Input** button 10 on the headphones.

Press the buttons repeatedly until one of the following displays lights up	Selected input ("IN") on the transmitter
☐ Analog	ANALOG IN 2
☐ Coaxial	COAXIAL IN 3
☐ Optical	OPTICAL IN 4

The selected input ("IN") on the transmitter is retained in memory when the transmitter is switched off.

Adjusting the signal of the audio source

The RS 220 digital RF headphone system deliberately does without an automatic adjustment of the signal level so that you can hear pure and unadulterated sound from your analog audio source.

The **LEVEL** control dial ⑳ allows you to individually adjust the transmitter to your audio source in order to achieve optimum sound quality.

- ▶ Switch the transmitter and the headphones on (see page 16).
- ▶ Select the **ANALOG IN** input ② (see page 21).
The **ANALOG LED** ⑫ lights up green.

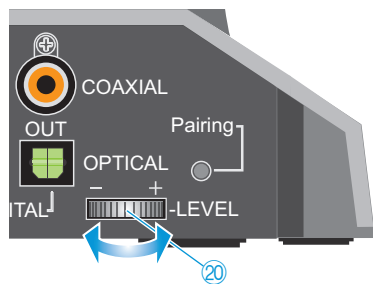

- ▶ Set the headphones to a medium volume (see page 23).
- ▶ First turn the **LEVEL** control dial ⑳ in the **+** direction until the audio signal is slightly distorted.
- ▶ Then minimally turn the **LEVEL** control dial ⑳ in the **-** direction until you can clearly hear the audio signal.
- ▶ Use the **Volume -/R** button ⑦ on the headphones to set a medium volume.

i If you connect a different audio source to the **ANALOG IN** input ②, you have to adjust the signal of the audio source again in order to achieve optimum sound quality.

Adjusting the volume on the headphones

- ▶ Press the **Volume –/R** button ⑦ or the **Volume +/L** button ⑤ repeatedly until the volume is adjusted to a comfortable level.

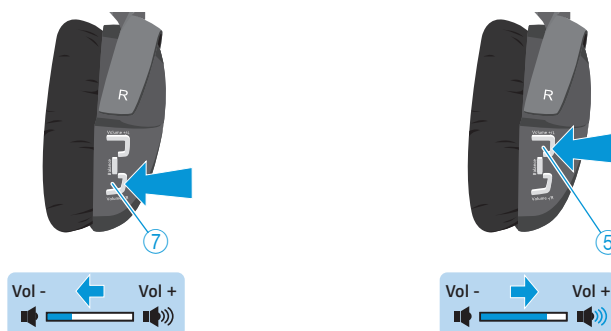

When the minimum or maximum volume is reached, you hear a beep in the headphones.

Adjusting the balance

The balance button allows for left/right volume adjustment. To adjust the volume for your left (L) or right (R) ear:

- ▶ Press the **Balance** button ⑥ to toggle between Volume and Balance.
- ▶ Press the **Volume +/L** button ⑤ or the **Volume –/R** button ⑦.

To adjust the same volume for both ears:

- ▶ Press the **Balance** button ⑥ for 2 seconds.

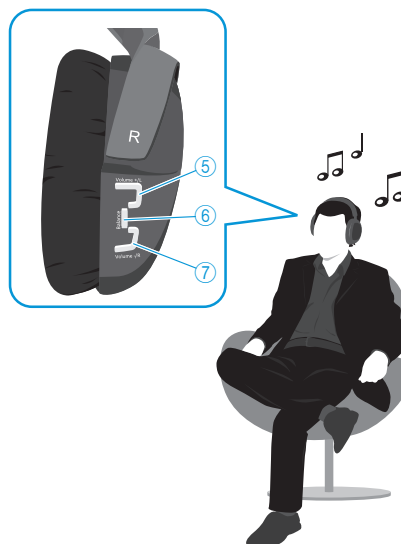

- i** If you don't press the **Volume +/L** button ⑤ or the **Volume –/R** button ⑦ within 5 seconds after you have pressed the **Balance** button ⑥, the current balance setting remains unchanged.

Associating a second pair of headphones to the transmitter

The headphones and the transmitter are already associated upon delivery. If you want to use a second pair of headphones, you have to associate it to the transmitter.

When associating the headphones to the transmitter, the distance between the transmitter and the headphones should not exceed 1 m.

- ▶ Switch the transmitter on (see page 16).
- ▶ Press the **On/Off** button ⑧ on both pairs of headphones to switch the headphones on.
The headphones search for a suitable transmitter. The **Power LED** ⑨ of the already associated headphones lights up while the **Power LED** ⑨ of the new headphones flashes.
- ▶ Press and hold the **On/Off** button ⑧ on the new pair of headphones until the **Power LED** ⑨ alternately flashes blue/red.
- ▶ Press the **Pairing** button ⑩ on the transmitter.
The **ON LED** ⑰ of the transmitter flashes green/red. After approx. 2 seconds, the headphones are paired with the transmitter and you can hear your audio source. The **Power LED** ⑨ of the headphones lights up blue, the **ON LED** ⑰ of the transmitter lights up green.

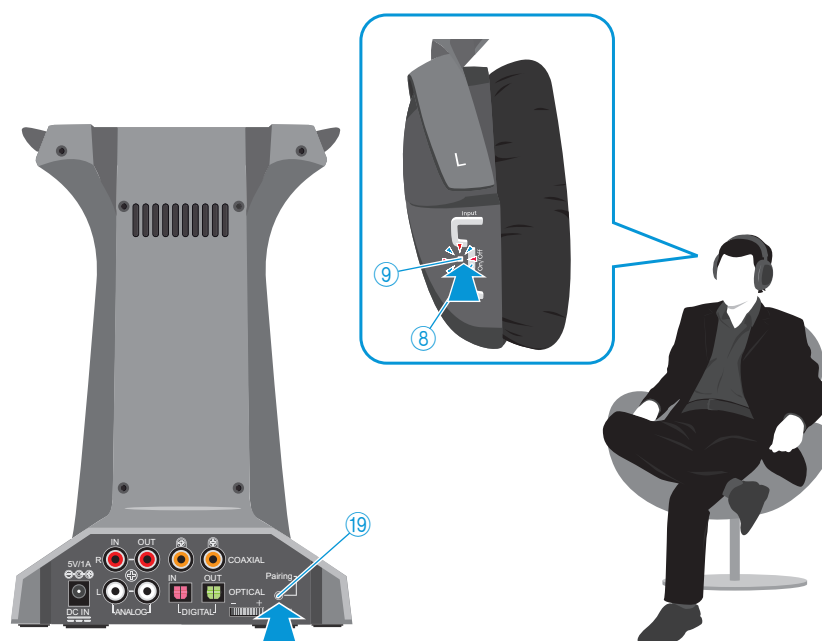

i The volume and the balance of the each pair of headphones can be adjusted individually.

Cleaning and maintaining the RS 220

CAUTION

Liquids can damage the electronics of the product!

Liquids entering the housing of the product can cause a short-circuit and damage the electronics.

- ▶ Keep all liquids far away from the product.
- ▶ Do not use any solvents or cleansing agents.

CAUTION

Microfiber cloths can damage the surface of the product!

If you clean the product with a microfiber cloth, dust particles can scratch the surface.

- ▶ Carefully dust the product without exerting pressure.
- ▶ Before cleaning, switch the headphones off and disconnect the transmitter from the mains.
- ▶ Only use a lint-free, slightly humid cloth to clean the product.
- ▶ Clean the charging contacts from time to time using e.g. an eraser.

Changing the rechargeable batteries of the headphones



For powering the headphones, you can use rechargeable batteries (HR03, AAA size, NiMH, 1.2 V) or standard batteries (AAA size, 1.5 V).

- ▶ Remove the depleted rechargeable batteries/standard batteries (where applies).
- ▶ Insert the rechargeable batteries/standard batteries. Observe correct polarity when inserting the batteries.
- ▶ Close the battery compartment ③.
The battery compartment cover locks into place with an audible click.

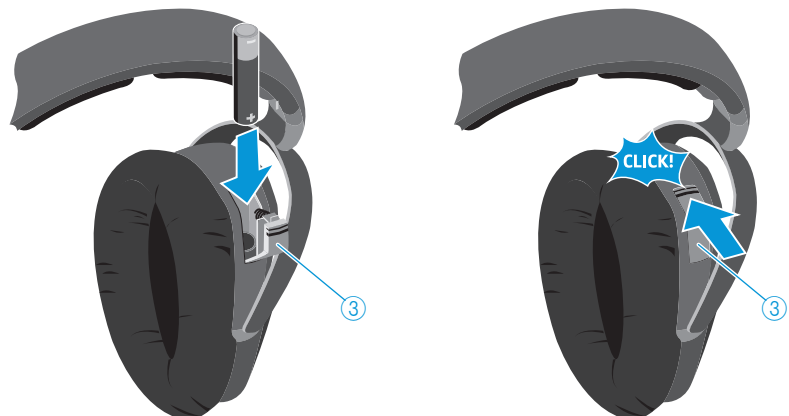

Replacing the ear pads

For reasons of hygiene, you should replace the ear pads from time to time. Spare ear pads are available from your Sennheiser dealer.

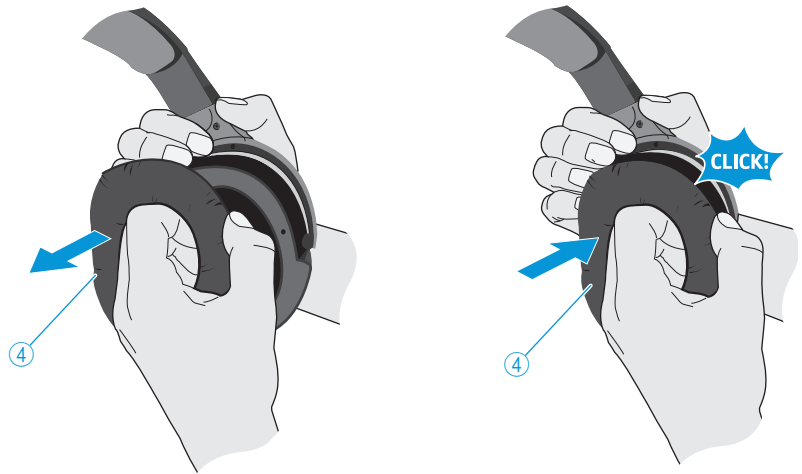

- ▶ Grasp inside the ear pads ④ and pull them up and away from the ear cups.
- ▶ Press the new ear pads ④ onto the ear cups until they lock into place with an audible click.

If a problem occurs ...

Sound problems

Problem	Possible cause	Possible solutions	Page
No sound	Transmitter is/headphones are switched off	Switch the transmitter/headphones on	16/19
	Plug is not properly connected	Check the plug connection	10
	Audio source is switched off	Switch the audio source on	–
	Audio source is not connected to the selected connection	Select a different audio source	21
	Audio cable is defective	Replace the cable or select a different connection	21
Occasional sound dropouts	Headphones are out of range	Reduce the distance between headphones and transmitter	–
Sound is too low	Signal of the audio source is too weak	Increase the volume of the audio source	–
	LEVEL control dial ⑳ is turned too far in the – direction	Turn the LEVEL control dial ⑳ in the + direction	22
Sound is too distorted	Signal of the audio source is too strong	Reduce the signal level by means of the LEVEL control dial ⑳	22
	LEVEL control dial ⑳ is turned too far in the + direction	Turn the LEVEL control dial ⑳ in the – direction	22
Sound only on one ear	The balance is misadjusted	Adjust the balance	23
	Audio cable is defective	Replace the cable	–
	1 RCA plug of the audio connection cable is not properly connected	Check the plug connection	10

Other problems

Problem	Possible cause	Possible solution	Page
The transmitter cannot be switched on	No mains connection	Check the connection of the power supply unit to the transmitter and to the mains	14
Headphones cannot be switched on	Rechargeable batteries are flat	Recharge the rechargeable batteries	14
	Rechargeable batteries are inserted the wrong way round	Remove the rechargeable batteries and observe correct polarity	25
Headphones and/or transmitter do not react to any key press	Function is disturbed	Reset: Pull out the mains plug from the transmitter, remove the rechargeable batteries from the headphones for 30s	16
Headphones cannot be recharged	Headphones do not make contact to the charging contacts	Ensure that the headphones are properly seated on the charging contacts	14
		Clean the charging contacts	25
Power LED  flashes continuously	Headphones haven't found an unused frequency	Place the transmitter in a different location	24
		If necessary, switch off a product operating on Bluetooth or WLAN	–

If a problem occurs that is not listed in the above table or if the problem cannot be solved with the proposed solutions, please contact your local Sennheiser partner for assistance.

To find a Sennheiser partner in your country, search at www.sennheiser.com.

Specifications

RS 220 system

Modulation	digital, 16-bit, 48 kHz
Frequency range	2400 to 2483.5 MHz
Frequencies	2412 MHz; 2438 MHz; 2464 MHz
Number of radio channels	3
AF frequency response	16 Hz to 22 kHz
Signal-to-noise ratio	typ. 90 dB
Operating temperature range	0°C to 40°C
Storage temperature range	-10°C to +70°C

TR 220 transmitter

Radiated RF power	10 mW
Power supply	PSM11R-090 power supply unit 9 V $\overline{\text{---}}$, 1.1 A
Power consumption	standby mode: typ. 0.30 W loop through mode: typ. 0.84 W switched on: typ. 2.2 W
Connections	analog: RCA digital coaxial: RCA digital optical: TORX/TOTX
Input sensitivity (analog) of the sockets	0.6 V _{rms} to 5 V _{rms}
Weight	approx. 484 g

HDR 220 headphones

Transducer principle	dynamic, open
Max. SPL at 1 kHz	106 dB (1 kHz, 1 V _{rms})
THD	typ. < 0.1% (1 kHz, 100 dB SPL)
Power supply	2 NiMH-rechargeable batteries (HR03, type AAA, 1.2 V)
Charging time	approx. 16 hours
Operating time	approx. 6 to 8 hours
Weight incl. rechargeable batteries	approx. 329 g

PSM11R-090 power supply unit

Rated input	100 – 240 V \sim , 0.3 A, 50 – 60 Hz
Rated output	9 V $\overline{\text{---}}$, 1.1 A
Operating temperature range	0°C to +40°C

Manufacturer declarations

Warranty

Sennheiser electronic GmbH & Co. KG gives a warranty of 24 months on this product. For the current warranty conditions, please visit our website at www.sennheiser.com or contact your Sennheiser partner.

In compliance with the following requirements

- RoHS Directive (2002/95/EC)
- WEEE Directive (2002/96/EC)
- Battery Directive (2006/66/EC)

CE Declaration of Conformity

- R&TTE Directive (1999/5/EC)
- EMC Directive (2004/108/EC)
- Low Voltage Directive (2006/95/EC)
- ErP Directive (2009/125/EC)

The declaration is available at www.sennheiser.com. Before putting the product into operation, please observe the respective country-specific regulations!

Rechargeable batteries



The supplied rechargeable batteries can be recycled. Please dispose of them as special waste or return them to your specialist dealer. In order to protect the environment, only dispose of exhausted batteries.









WEEE Declaration



Your Sennheiser product was developed and manufactured with high-quality materials and components which can be recycled and/or reused. This symbol indicates that electrical and electronic equipment must be disposed of separately from normal waste at the end of its operational lifetime.

Please dispose of this product by taking it to your local collection point or recycling centre for such equipment. This will help to protect the environment in which we all live.

In compliance with:

Country	Certification Mark / Number	
	Transmitter	Headphone
USA	FCC ID: DMORS220T	FCC ID: DMORS220H
Canada	IC: 2099A-RS220T	IC: 2099A-RS220H
Europe	CE 0560	CE 0560
Japan	 R 201 WW 11215100	 R 201 WW 11215099
Australia/ New Zealand	 N340	
Singapore	Complies with IDA Standards DB100582	
Taiwan	 CCAI11LP0940T2	 CCAI11LP0930T9
China	 15 CMIIT ID: 2011DJ2907	 15 CMIIT ID: 2011DJ2906
Korea	 KCC-CRM-SE9-TR220	 KCC-CRM-SE9-HDR220

Statements regarding FCC and Industry Canada

FCC Declaration of Conformity (DoC)



We,

Sennheiser Electronic Corporation
 One Enterprise Drive • Old Lyme •
 CT 06371 • USA
 Tel: +1 (860) 434 9190, ext. 144
 Fax: +1 (860) 434 1759

declare the above device comply with the requirements of Federal Communications Commission.

This device complies with Part 15 of the FCC rules. Operation is subjected to the following two conditions:

- 1) This device may not cause harmful interference, and
- 2) This device must accept any interference received, including interference that may cause undesired operation.

Responsible Party: John Falcone

This device complies with Part 15 of the FCC rules and RSS-210 of Industry Canada. Operation is subjected to the following two conditions: 1) This device may not cause harmful interference, and 2) This device must accept any interference received, including interference that may cause undesired operation.

This equipment has been tested and found to comply with the limits for a Class B digital device, pursuant to part 15 of the FCC Rules. These limits are designed to provide reasonable protection against harmful interference in a residential installation. This equipment generates, uses and can radiate radio frequency energy and, if not installed and used in accordance with the instructions, may cause harmful interference to radio communications. However, there is no guarantee that interference will not occur in a particular installation. If this equipment does cause harmful interference to radio or television reception, which can be determined by turning the equipment off and on, the user is encouraged to try to correct the interference by one or more of the following measures:

- Reorient or relocate the receiving antenna.
- Increase the separation between the equipment and receiver.
- Connect the equipment into an outlet on a circuit different from that to which the receiver is connected.
- Consult the dealer or an experienced radio/TV technician for help.

Changes or modifications made to this equipment not expressly approved by Sennheiser electronic Corp. may void FCC authorization to operate this equipment. This Class B digital apparatus complies with Canadian ICES-003.

RF Radiation Exposure Information

Since the radiated output power of this device is far below the FCC radio frequency exposure limits, it is not subjected to routine RF exposure evaluation as per Section 2.1093 of the FCC rules. This device complies with the US and Industry Canada portable device RF exposure limits set forth for an uncontrolled environment and is safe for intended operation as described in the user manual. Further RF exposure reduction can be achieved if the device can be kept as far as possible from the user's body or set to lower output power if such provision is available. The base portion of this device should be installed and operated at least 20 cm away from the user's body. Use of other accessories not verified by the manufacturer may not ensure compliance with FCC and Industry Canada RF exposure guidelines. This transmitter must not be co-located or operated in conjunction with any other antenna or transmitter.

Industry Canada statement

This device complies with RSS-210 of Industry Canada. Operation is subjected to the following two conditions: (1) This device may not cause harmful interference, and (2) this device must accept any interference received, including interference that may cause undesired operation.

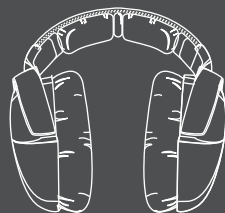
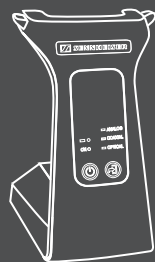

Sennheiser electronic GmbH & Co. KG

Am Labor 1, 30900 Wedemark, Germany
www.sennheiser.com

Publ. 02/12, 542639/A03

 **SENNHEISER**