

MM 550-X



Instruction manual

 **SENNHEISER**

Contents

- Important safety instructions 2**
- MM 550-X 4**
- Delivery includes 6**
- Product overview 8**
- Putting the MM 550-X into operation 9**
 - Charging the battery pack 9
 - Adjusting the headband 11
 - Connecting the MM 550-X to the audio source 12
 - Connecting the MM 550-X using the audio cable 14
 - Switching the MM 550-X on/off 15
- Using the MM 550-X 16**
 - Adjusting the MM 550-X to the listening situation 16
 - Changing the volume 17
 - Remote-controlling connected devices from the
MM 550-X 18
- Transporting the MM 550-X 21**
- Cleaning and maintaining the MM 550-X 22**
- If a problem occurs 23**
- Specifications 25**
- Valuable information on MM 550-X 26**
 - SRS WOW HD 26
 - apt-X audio coding 27
- Manufacturer Declarations 29**

Important safety instructions

- ▶ Read this instruction manual carefully and completely before using the product.
- ▶ Always include this instruction manual when passing the product on to third parties.
- ▶ Do not use an obviously defective product.

Preventing damage to health and accidents

- ▶ Do not listen at high volume levels for long periods of time to prevent hearing damage.
- ▶ Always maintain a distance of at least 3.94" (10 cm) between the ear cups and the cardiac pacemaker or implanted defibrillator since the product generates permanent magnetic fields.
- ▶ Keep the product, accessory and packaging parts out of reach of children and pets who could swallow smaller pieces.
- ▶ Do not use the product in an environment that requires your special attention (e.g. in traffic).

Preventing damage to the product and malfunctions

- ▶ Always keep the product dry and do not expose it to extreme temperatures (hairdryer, heater, extended exposure to sunlight, etc.) to avoid corrosion or deformation.
- ▶ Only clean the product with a soft, dry cloth.
- ▶ Switch off the product after use to conserve battery power. Remove the battery pack if the product will not be used for extended periods of time.
- ▶ Only use the product in environments where wireless **Bluetooth**® transmission is permitted.
- ▶ Only use attachments/accessories supplied or recommended by Sennheiser.

Intended use

The MM 550-X is a wireless **Bluetooth** headset that works with mobile phones or other **Bluetooth** devices/**Bluetooth** compliant devices and allows for wireless music enjoyment or calls.

"Improper use" means using the product

- other than as described in this instruction manual,
- under operating conditions which differ from those described in this instruction manual.















Safety instructions for the Lithium-Polymer battery pack

If abused or misused, the battery pack may leak. In extreme cases, it may even present an explosion or fire hazard.



- Heat generation
- Fire development
- Explosion
- Smoke or gas development

Please understand that Sennheiser does not accept liability for damage arising from abuse or misuse.

	Keep away from children.		When not using the product for extended periods of time, remove the battery pack from the product.
	Immediately remove the battery pack from an obviously defective product.		Only use battery packs recommended by Sennheiser.
	Dispose of the battery pack at special collection points or return it to your specialist dealer.		Switch battery pack-powered products off after use.
	Only charge the battery pack with the appropriate Sennheiser chargers.		When not using the battery pack for extended periods of time, charge it regularly (about every 3 months).
	Only charge the battery pack at ambient temperatures between 10°C/50°F and 40°C/104°F.		Do not heat above 70°C/158°F, e.g. do not expose to sunlight or throw into a fire.
	Do not mutilate or dismantle.		Do not continue to use a defective battery pack.
	Store charged battery packs so that the terminals cannot contact each other – danger of shorting out/fire hazard.		Do not expose to moisture.

MM 550-X

The MM 550-X is an accessory which allows for wireless music enjoyment when used with mobile phones or other **Bluetooth** devices/**Bluetooth** compliant devices. Its circumaural, closed design and the latest active noise compensation technology (NoiseGard) makes the MM 550-X especially suitable for use with in-flight entertainment systems. Due to its active and passive attenuation of ambient noise, it lets you enjoy music even in noisy environments.

Bluetooth



The MM 550-X complies with the **Bluetooth 2.1** standard. Via its **Bluetooth** interface, it can be connected to a wide variety of **Bluetooth** enabled devices. Bluetooth wireless technology allows the MM 550-X to communicate with your **Bluetooth** enabled device (e.g. mobile phone, MP3 player, PC or PDA) within a range of up to 10 meters.



SRS WOW HD™

SRS WOW HD improves the dynamic audio performance of compressed and uncompressed audio by expanding the size of the audio image and creating a deep, rich bass response. The patented techniques in SRS WOW HD widen the horizontal sound field and raise the vertical sound image, retrieving information lost in the mixing process to create a more natural audio experience.



apt-X

With apt-X audio coding, you can be assured of crisp, pure and full stereo sound. It allows you to not only hear, but experience and feel the audio as it was intended. Utilizing apt-X, **Bluetooth** technology can now offer wireless audio quality that is indistinguishable from the highest quality wired connection.

From major public broadcasters to film production studios, apt-X is used throughout the world to transmit high quality digital audio from A to Z in real-time. It was developed to meet the exacting standards of musicians and audio engineers who love the exceptional dynamic range and high fidelity it provides.

Now available on selected consumer devices, the apt-X technology ensures that music lovers everywhere can stream the rich listening experience that only apt-X can deliver.



NoiseGard™

The NoiseGard active noise compensation system is based on the principle of cancelling out sound using "anti-sound" (phase-inverted sound). Tiny microphones pick up low-frequency ambient noise (up to 1 kHz) near the ear. The NoiseGard electronics use this noise to generate a sound wave which is the exact opposite (IE: at the same level but polarity reversed – 180° out-of-phase), the effect being that the polarity reversed signal cancels most of the outside noise.

TalkThrough

The MM 550-X has a TalkThrough function, which allows you to communicate with other people without having to remove the headset. When TalkThrough is activated, professional quality microphones mounted on the outside of the headset pick up all acoustic signals in the immediate vicinity. Annoying background noise is electronically filtered out, only allowing the voice of the other person to pass through the headset clearly.

Additional features

- Great for travel: comfortable, rugged and foldable headset construction
- Optional connection via audio cable for music enjoyment without Bluetooth technology
- Outstanding sound quality due to Duofol diaphragms
- Optimum protection against ambient noise due to active and passive noise attenuation

Delivery includes



MM 550-X headset



BA 370 PX battery pack



USB charging cable

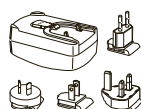

Mains unit with country adapters



Stereo audio cable
(2.5 mm to 3.5 mm jack plug)



Audio adapter
(3.5 mm jack socket to 1/4" (6.35 mm) jack plug)

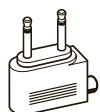

In-flight adapter
(3.5 mm jack socket to 3.5 mm double mono jack plug)



Transport case



Quick start guide incl. CD ROM with detailed instruction manual as PDF



Safety guide



Manufacturer Declarations





A list of accessories can be found on the MM 550-X product page at www.sennheiser.com.



For information on suppliers, contact your local Sennheiser partner: www.sennheiser.com > "Service & Support".

Overview of the pictograms



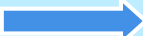

Meaning of the pictograms for pressing a button

Pictogram	Meaning
	Briefly press this button.
	Keep this button pressed for 4 seconds.
	Keep this button pressed until the desired setting is made or the desired action is completed.

Meaning of the pictograms for the flashing of the LED

Pictogram	Meaning
	This pictogram symbolizes a flashing.
	This pictogram symbolizes an interruption.
	This pictogram symbolizes an interval.
	This pictogram symbolizes a continuous flashing.

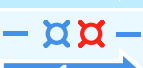
Examples of some of the pictograms that are used throughout this instruction manual:

Pictogram	Meaning
	The LED flashes once every 3 seconds.
	The LED flashes 3 times per second.
	The LED flashes in a rhythmic sequence.
	The LED flashes blue 3 times and then goes off.

The pictogram “i”

 **This note provides important information!**
 Notes marked with the pictogram “i” provide important information on the use of the headset.

Product overview

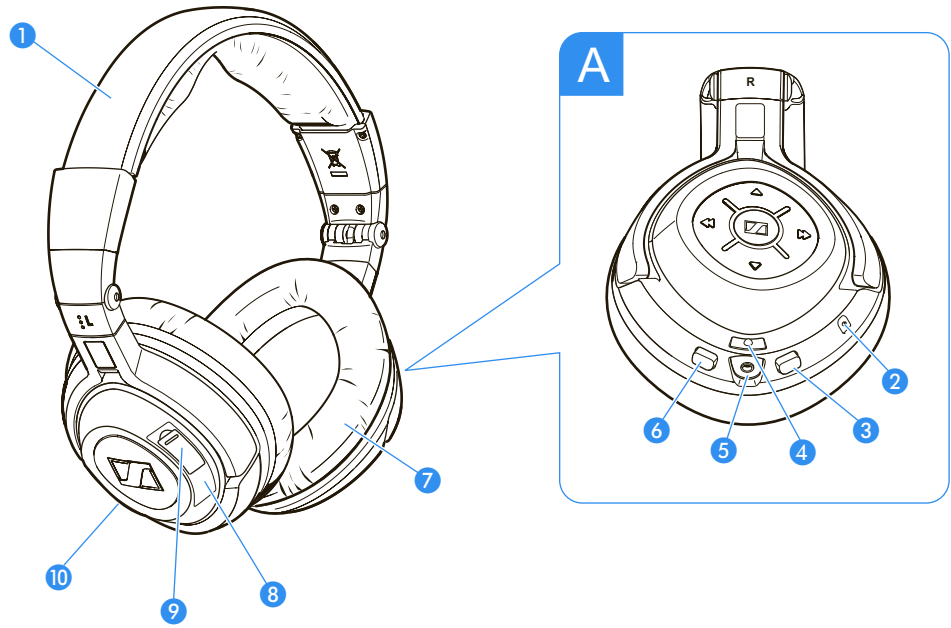

- 1 Headband
- 2 Microphone
- 3 NoiseGard button
- 4 SRS button
- 5 Socket for audio cable
- 6 Bluetooth button
- 7 Ear pad
- 8 Socket for charging cable
- 9 Battery pack compartment
- 10 Microphone

A Operating panel

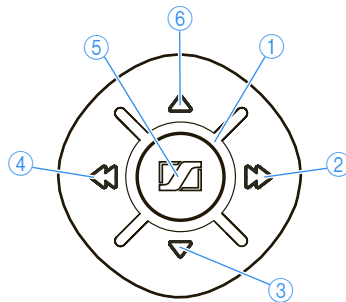

- 1 LED
- 2 Fast-forward button
- 3 Volume down button
- 4 Rewind button
- 5 Master button
- 6 Volume up button

Putting the MM 550-X into operation

- ▶ Before using the MM 550-X for the first time, remove the protection strip from the battery pack.

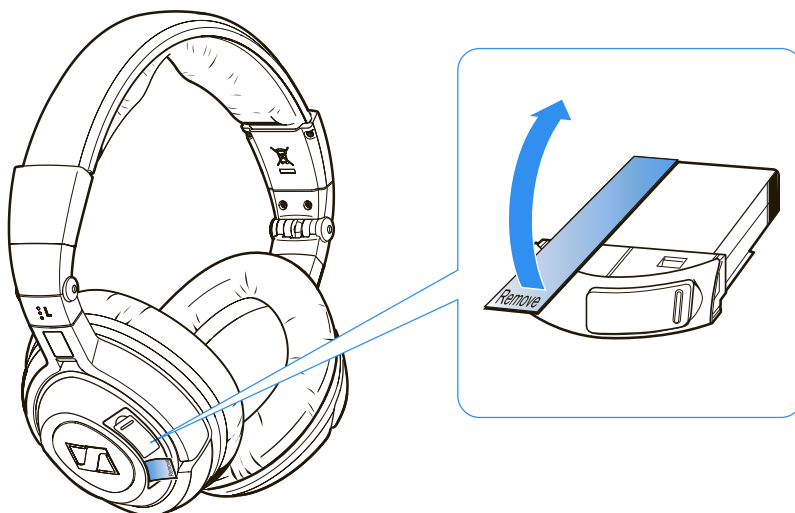

Charging the battery pack

- ▶ Before using the battery pack for the first time, charge it for at least 3 hours. The battery pack can also be charged inside the headset during operation.

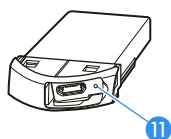

When charging the battery pack, the LED 11 on the battery pack lights up red. When the battery pack is fully charged, the LED 11 on the battery pack lights up green.



When the battery pack is almost flat, the LED 1 flashes red. You hear a short, descending acknowledgement tone.

The operating time of the battery pack depends on the device settings, the listening situation and the audio sources used. The operating time will be reduced if you use SRS WOW HD.

Type of use	Operating time
NoiseGard and Bluetooth technology	8 hours
NoiseGard without Bluetooth technology	20 hours
Bluetooth technology without NoiseGard	10 hours

- i** Remove the battery pack if the headset will not be used for extended periods of time.

Possibilities of charging the battery pack

First, connect the charging cable 12 to the battery pack as described in section a and then connect the charging cable 12 to a power source as described in section b.

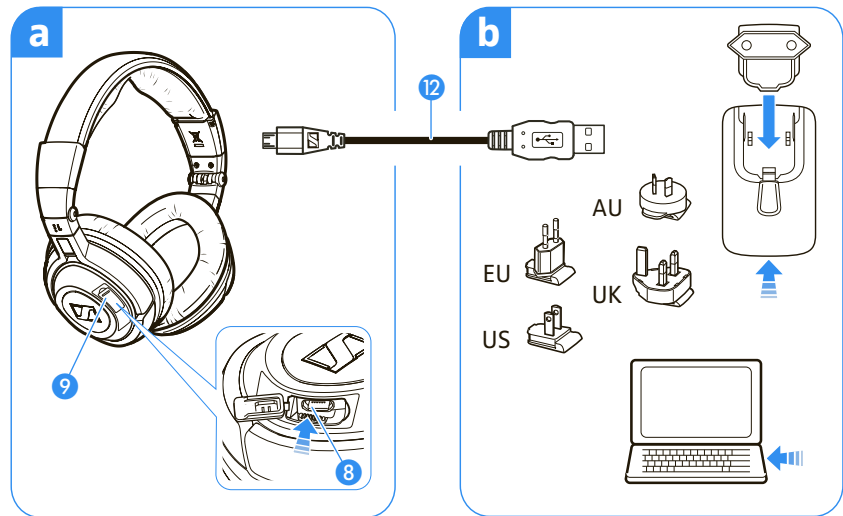

a Connecting the charging cable to the battery pack

You can charge the battery pack either inside or outside the headset. This is helpful if you are using a spare battery pack (to be ordered separately).

To charge the battery pack **inside** the headset:

- ▶ Open the cover of the battery pack compartment 9 on the left ear cup.
- ▶ Connect the charging cable 12 to the socket for charging cable 8 on the headset.

To charge the battery pack **outside** the headset:

- ▶ Open the cover of the battery pack compartment 9 on the left ear cup.
- ▶ Press the button next to the battery pack compartment and remove the battery pack.

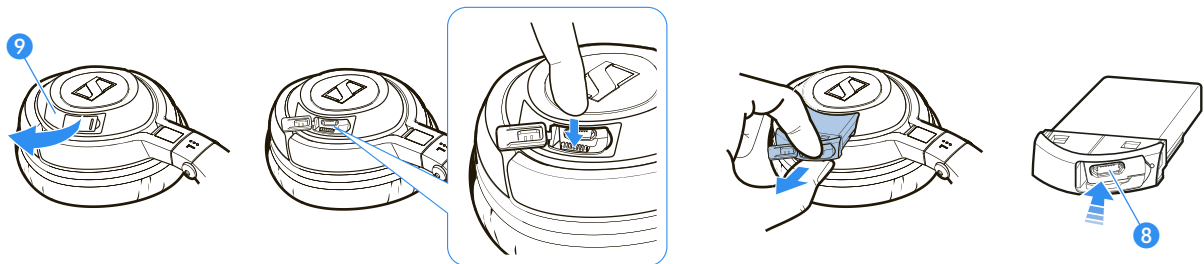

- ▶ Connect the charging cable 12 to the socket for charging cable 8 on the battery pack.

b Connecting the charging cable to the mains unit, to a PC or to other USB devices

In order to charge the battery pack, you can connect the charging cable to either the USB socket of your PC or the supplied mains unit or to other USB devices.

To connect the charging cable **to a PC**:

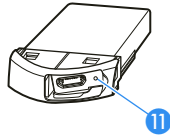

- ▶ Connect the USB plug of the charging cable **12** to the USB socket of your PC.
- The battery pack is being charged. The LED **11** on the battery pack lights up red.

To connect the charging cable **to the mains unit**:

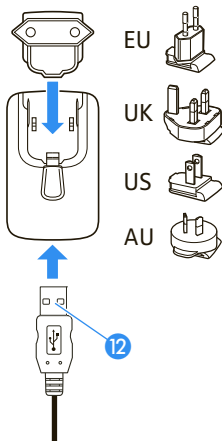

- ▶ Connect the charging cable **12** to the mains unit.
- ▶ Plug the suitable country adapter onto the mains unit.
- ▶ Plug the mains unit into a wall socket.
- The battery pack is being charged. The LED **11** on the battery pack lights up red.
- ▶ After charging, unplug the mains unit from the wall socket.

If you have charged the battery pack **outside** the headset:

- ▶ Insert the charged battery pack into the headphone's battery pack compartment until it locks into place.
- ▶ Close the cover of the battery pack compartment **9**.

Adjusting the headband

For optimum transmission quality, good noise attenuation and best possible comfort, the headband has to be adjusted to properly fit your head:

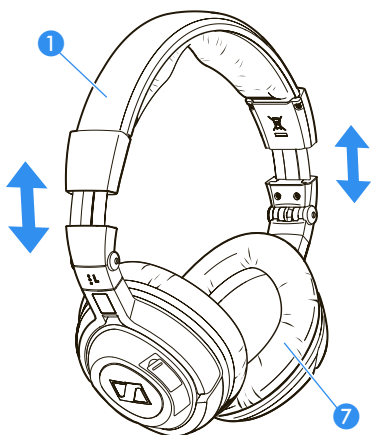

- ▶ Wear the headset so that the headband **1** runs over the top of your head.
- ▶ Adjust the length of the headband so that
 - the ear pads **7** rest comfortably against the ears,
 - you feel even, gentle pressure around your ears,
 - a snug fit of the headband **1** on the head is ensured.
- ▶ To ensure maximum noise attenuation, final adjustment is best made in a noisy environment.

Connecting the MM 550-X to the audio source

CAUTION

Danger of malfunction due to radio waves!

The transmitted radio waves of mobile phones can impair the operation of sensitive and unprotected devices.

- ▶ Only use the headset in environments where wireless **Bluetooth** transmission is permitted.

The headset complies with the **Bluetooth** 2.1 standard. In order that data can be transmitted wirelessly using **Bluetooth** technology, you have to register your headset with your audio source (pairing).

The headset can save the connection profiles of up to 8 **Bluetooth** devices with which it has been paired. After switch-on, the headset automatically connects to one of these devices.

If you pair the headset with a ninth audio source, the saved connection profile of the first **Bluetooth** device will be overwritten. If you want to re-establish a connection with the first audio source, you have to pair the headset with this audio source again.

- ▶ If your audio source does not have a **Bluetooth** interface, use an optional dongle.

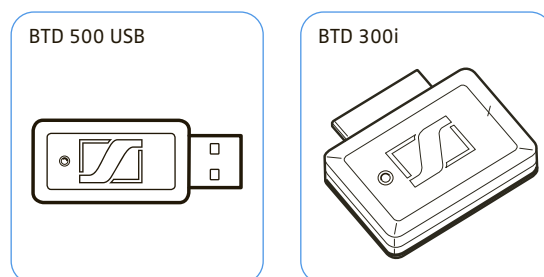

- i** For an optimum listening experience, your audio source has to support the A2DP profile.

Pairing the MM 550-X with an audio source

i ▶ Make sure that your headset is switched off (see “Switching the MM 550-X off” on page 15).

When switching the headset on **for the first time**, it will automatically go into pairing mode. The headset is waiting to be paired with a **Bluetooth** enabled device.

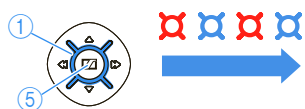

▶ Press the **Master** button (5) and keep it pressed until the **LED** (1) alternately flashes blue and red.

▶ On your audio source, activate the **Bluetooth** function “Add a new device”.

▶ Proceed as described in the instruction manual of the audio source.



If a suitable audio source is found, the devices will exchange device identification information. The **LED** (1) flashes 3 times blue and you hear an ascending beep. The devices have identified each other and the headset is paired with the audio source.

i PIN code

When the audio source prompts for a password or PIN code, enter the default PIN code “0000”.

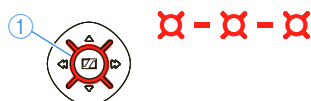

If no device is found within approx. 5 minutes, the **LED** (1) flashes 3 times red and you hear a descending beep. The headset will then try for 3 minutes to connect to one of the up to 8 previously paired audio sources. If this fails, the headset automatically switches off after 60 minutes.

▶ In this case, repeat the necessary steps to pair the headset with the audio source again.

Disconnecting the Bluetooth connection

The **Bluetooth** button (6) is backlit, indicating the current setting. The backlighting goes off after a short time to conserve energy.

▶ Press any button on the headset to display the current setting of the **Bluetooth** function.

To disconnect the **Bluetooth** connection to the audio source, you can switch off the headset or the **Bluetooth** function. This setting is retained until the **Bluetooth** function is switched on again.

To switch the headset off:

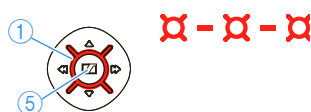

▶ Press the **Master** button (5) and keep it pressed until the **LED** (1) flashes 3 times red.

You hear a descending beep. The **Bluetooth** connection is automatically deactivated. The headset switches off.

To switch the **Bluetooth** function off:



▶ Press the **Bluetooth** button (6) and keep it pressed until the **LED** (1) flashes 3 times red. You hear a descending beep.

The **Bluetooth** button (6) goes off. The **Bluetooth** function is switched off.

Connecting the MM 550-X using the audio cable

Connecting the audio cable

You can connect the headset to the audio source using the audio cable if:

- you do not want to use the **Bluetooth** function,
- you are not allowed to use the **Bluetooth** function (some airlines do not allow **Bluetooth** transmission)
or
- the battery pack is flat.

 When the audio cable is connected to the headset, the **Bluetooth** function cannot be switched on.

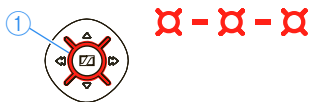

If the headset is already connected to the audio source via the **Bluetooth** interface, the **Bluetooth** connection is automatically disconnected when you connect the audio cable. The  LED ① flashes 3 times red and you hear a descending beep.

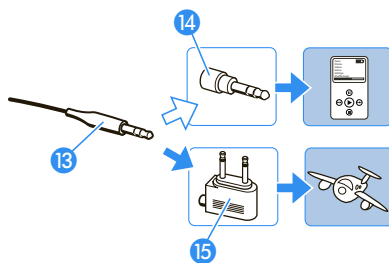

- ▶ Connect the 2.5 mm jack plug of the audio cable to the socket ⑤ of the headset.
- ▶ Connect the 3.5 mm jack plug of the audio cable ⑬ to
 - the headphone socket of your audio source or
 - the audio adapter for ¼" (6.35 mm) jack socket ⑭ if the 3.5 mm jack plug of the audio cable is too small or
 - the in-flight adapter ⑮ if you want to use the headset with an in-flight entertainment system.



When the audio cable is connected to your audio source, you hear the sound from your audio source and the  LED ① flashes blue.

Detaching the audio cable

If you only want to use the MM 550-X as a **Bluetooth** headset, you can detach the audio cable ⑬.

- ▶ Pull the 2.5 mm jack plug of the audio cable ⑬ from the socket ⑤ of the headset.

When detaching the audio cable, the **Bluetooth** function is not automatically switched on.

- ▶ Switch the **Bluetooth** function on again (see "Switching the **Bluetooth** function on/off" on page 17).

Switching the MM 550-X on/off



WARNING

Danger of hearing damage!

Listening at high volume levels for long periods can lead to permanent hearing defects.

- ▶ Before putting the headset on, set the volume to a low level.
- ▶ Do not continuously expose yourself to high volumes.

Switching the MM 550-X on

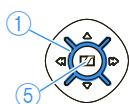

- ▶ Press the **Master** button ⑤ and keep it pressed until the LED ① flashes blue. You hear an ascending beep.
 - When switching the headset on **for the first time**, it will automatically go into pairing mode. The headset is waiting to be paired with a **Bluetooth** enabled device (see page 13).
 - When the headset **is already paired with an audio source**, the **Bluetooth** connection is automatically established. You hear an ascending beep and then you hear your audio source.
 - When the headset **is already paired with an audio source** but the **audio source** is **switched off** or out of range, the LED ① flashes blue. The headset will try for 3 minutes to connect to one of the up to 8 previously paired audio sources. If this fails, the headset automatically switches off after 60 minutes.

Switching the MM 550-X off

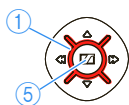

- ▶ Press the **Master** button ⑤ and keep it pressed until the LED ① flashes 3 times red. You hear a descending beep. The **Bluetooth** connection is automatically deactivated. The headset switches off.

Using the MM 550-X

Adjusting the MM 550-X to the listening situation

The headset has a SRS WOW HD function, a NoiseGard function, a Bluetooth function and a TalkThrough function. Depending on the listening situation, you can switch these functions on or off.



If your audio source supports apt-X, the MM 550-X automatically streams music wirelessly in high quality (apt-X). If your audio source does not support apt-X, music is streamed in standard quality (SBC).

Switching the SRS WOW HD function on/off

SRS WOW HD ensures enhanced sound quality and bass boost performance, thus allowing for a spectacular sound experience.

To switch the SRS WOW HD sound enhancement on:

- ▶ Briefly press the **SRS** button **4**.
The button is backlit in yellow and the SRS WOW HD function is switched on.

To switch the SRS WOW HD sound enhancement off:

- ▶ Briefly press the **SRS** button **SRS 4**.
The yellow backlighting goes off and the SRS WOW HD function is switched off.

Switching the NoiseGard function on/off

The **NoiseGard** button **3** is backlit, indicating the current setting. The backlighting goes off after a short while in order to conserve energy.

- ▶ Press any button on the headset to display the current setting of the NoiseGard active noise compensation.

The NoiseGard function has to be switched on to be active. If the NoiseGard function is switched off, the MM 550-X can also be used as a conventional headset.

To switch the NoiseGard function on:

- ▶ Press the **NoiseGard** button **3** for 2 seconds.
The button is backlit in red and the NoiseGard function is switched on.

To switch the NoiseGard function off:

- ▶ Press the **NoiseGard** button **3** for 2 seconds.
The red backlighting goes off and the NoiseGard function is switched off.

Conserving energy

Switch the NoiseGard function off after use to conserve energy.



Switching the TalkThrough function on/off

The MM 550-X provides excellent attenuation of ambient noise. The Talk-Through function allows you to communicate undisturbed with other people without having to remove the headset even when NoiseGuard is switched on.

To switch the TalkThrough function on:



- ▶ Briefly press the **NoiseGuard** button **3**.
The  LED **1** lights up red. The TalkThrough function is switched on.

To switch the TalkThrough function off:

- ▶ Briefly press the **NoiseGuard** button **3**.
The  LED **1** goes off. The TalkThrough function is switched off.

 When the TalkThrough function is switched on, you cannot listen to music.

Switching the Bluetooth function on/off



Via the **Bluetooth** interface, the headset can be connected to a wide variety of **Bluetooth** enabled devices.

To switch the **Bluetooth** function on:















- ▶ Press the **Bluetooth** button **6** and keep it pressed until the  LED **1** flashes 3 times blue. The **Bluetooth** function is switched on.

To switch the **Bluetooth** function off:

- ▶ Press the **Bluetooth** button **6** and keep it pressed until the  LED **1** flashes 3 times red. You hear a descending beep.
The **Bluetooth** button **6** goes off. The  LED **1** flashes blue and the **Bluetooth** function is switched off.

Changing the volume

The MM 550-X allows you to change the volume of the audio signal during a call or while listening to music:

Button	Duration	Function
		 Incrementally increases the volume
		 Incrementally reduces the volume
		 Continuously increases the volume
		 Continuously reduces the volume



















If you press the respective button briefly, the volume is changed incrementally; if you hold down the button, the volume is changed continuously. When the minimum or maximum volume is reached, you hear an acknowledgement tone.

Remote-controlling connected devices from the MM 550-X

You can directly remote-control any device supporting the AVRCP profile and connected to the MM 550-X by using the buttons on the headset. Please refer to the instruction manual of your audio source for information on whether your device supports the AVRCP profile.

Remote-controlling the audio source from the MM 550-X

If your headset has a **Bluetooth** connection to an audio source (e.g. mobile phone, iPod, MP3 or CD player), you can use the MM 550-X to remote-control the audio source as follows:

Button	Duration	Function
		 Plays the track
		 Stops the track (acknowledgement tone)
		 Skips to the next track
		 Skips to the previous track
		 Fast-forwards the track *
		 Rewinds the track *

* These functions are not supported by all connected **Bluetooth** devices.

Managing calls

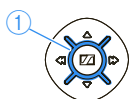

When your MM 550-X is connected to a mobile phone and you receive a call, the LED 1 flashes blue 3 times per second. You can also hear the ring tone of your mobile phone if your mobile phone supports this function.

If your mobile phone automatically transfers the call to the headset, you hear a beep in the headset. If your mobile phone does not automatically transfer the call to the headset, you have to press a button on your mobile phone to transfer the call (see the instruction manual of your mobile phone).



▶ To manage your calls from your MM 550-X, press the **Master** button 5 or the **Bluetooth** button 6:

Button	Duration	Function
		Accepts the call
		Rejects the call (acknowledgement tone)
		Ends the call
		Transfers the ongoing call back to the mobile phone

Redialing

The redialing function must be supported by your mobile phone or **Bluetooth** device (with HF profile respectively) and be activated.



▶ To redial the last number from your MM 550-X, press the **Bluetooth** button 6:







Button	Duration	Function
		Redials the last number (acknowledgement tone)
		Stops redialing

Voice dialing

The voice dialing function must be supported by your mobile phone (with HF profile) and be activated. Follow the instructions in the instruction manual of your mobile phone.







- ▶ To activate the voice dialing function from your MM 550-X, press the **Bluetooth** button **6**:

Button	Duration	Function
		 Activates voice dialing
		 Deactivates voice dialing

Muting the headset's microphone

- ▶ To mute the microphone on your MM 550-X, press the the **Bluetooth** button **6**:



Button	Duration	Function
		 Activates the muting function (acknowledgement tone)
Any button		 Deactivates the muting function

Switching the Bluetooth function off

If you press the **Bluetooth** button **6** too long, the Bluetooth function switches off!

Transporting the MM 550-X

For space-saving transportation, the headset can be folded up **flatly** and **compactly**.

- ▶ Rotate the ear cups by 90°.
- ▶ Fold the ear cups inwards.
- ▶ Place the headset flat into the transport case.

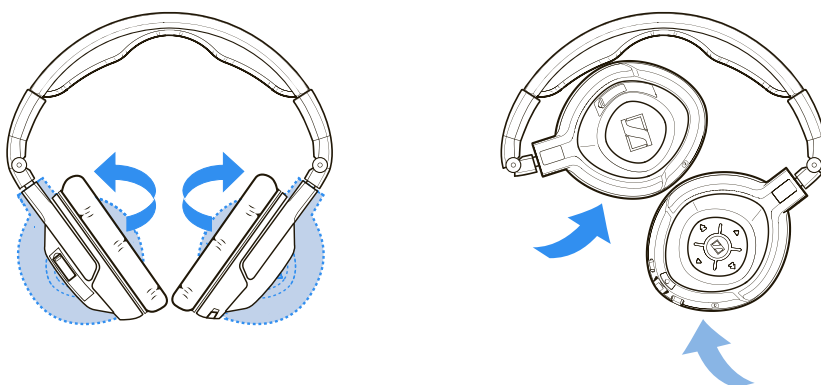

Your accessories can be transported in the front bag of the transport case:

- Audio adapter (1/4" (6.35 mm) jack plug)
- In-flight adapter (3.5 mm double mono jack)

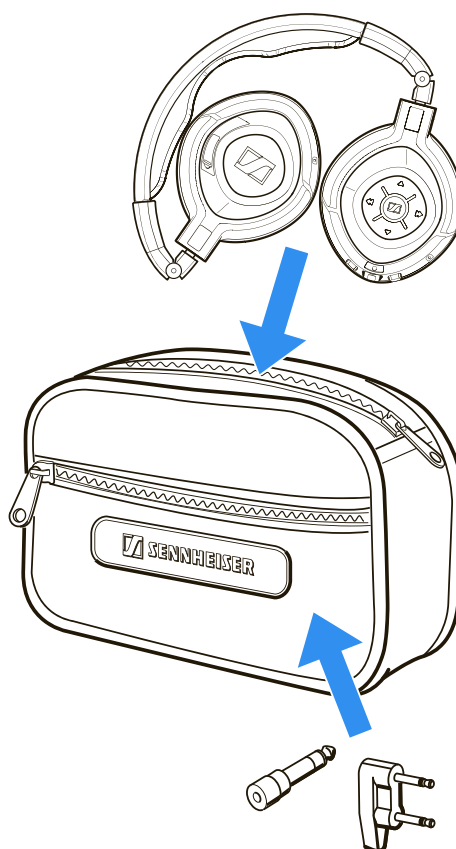

Cleaning and maintaining the MM 550-X

Cleaning the MM 550-X

CAUTION

Liquids can damage the electronics of the product!

Liquids entering the housing of the product can cause a short-circuit and damage the electronics.

- ▶ Keep all liquids far away from the product.
- ▶ Do not use any solvents or cleansing agents.

For reasons of hygiene, you should clean the headset regularly:

- ▶ Before cleaning, make sure that the product is not recharged via the mains.
- ▶ Only use a dry and soft cloth to clean the product.

Replacing the ear pads

You can replace the ear pads. Spare ear pads are available from your Sennheiser partner or can be ordered at www.sennheiser.com under "Service & Support".

- ▶ Grasp the edge of the ear pad ⑦ behind the ear cup and peel it up and away from the ear cup.
- ▶ Slide the new ear pad ⑦ onto the ear cup.

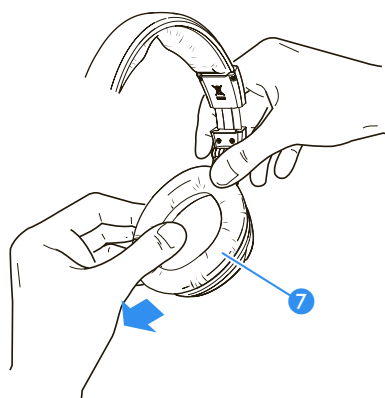

If a problem occurs ...

Problem	Possible cause	Solution	Page
No operation indicator – headset cannot be switched on	The battery pack is flat.	Recharge the battery pack.	9
No audio signal when the audio cable is connected	The jack plug of the audio cable is not properly connected.	Check the connection to your audio source.	14
No audio signal during Bluetooth connection	The headset is switched off.	Switch the headset on.	15
	The headset is not paired with an audio source.	Check if the headset is paired. If necessary, pair the headset with the audio source again.	13
	The Bluetooth function on the headset is switched off.	Switch the Bluetooth function on the headset on.	17
	The audio cable is connected to the headset.	The connection of the audio cable automatically switches off the Bluetooth connection. Remove the audio cable and then switch the Bluetooth function on again.	14
	The volume is adjusted too low.	Increase the volume.	17
Headset cannot be paired	The pairing does not work.	Check if the audio source supports the A2DP profile. If not, use one of the optional dongles.	–
	The audio source is switched off.	Switch the audio source on.	12
No audio signal during NoiseGard operation	The headset is switched off.	Switch the headset on.	15
	The TalkThrough function is switched on. When in Talk-Through mode, the audio signal is not available.	Switch the TalkThrough function off.	17

Problem	Possible cause	Solution	Page
Headset do not react to any button press	The operation of the headset is faulty.	Remove the battery pack from the headset. Reinsert the battery pack into the headset. Switch the headset on again.	–
Bluetooth connection is suddenly interrupted	The Bluetooth button has been pressed too long.	Switch the Bluetooth function on.	17

If a problem occurs that is not listed in the above table or if the problem cannot be solved with the proposed solutions, please contact your Sennheiser partner for assistance.

To find a Sennheiser partner in your country, search at www.sennheiser.com.

Resetting the settings of the MM 550-X

You can reset all settings of your headset to the factory default settings. This allows you to prevent that other users of the headset can access your Bluetooth enabled devices. You can then pair eight new devices with the headset.

▶ Press the **Master** button ⑤ and keep it pressed until the **LED** ① flashes 3 times red. The headset switches off (see "Switching the MM 550-X off" on page 15).

▶ Press the **Master** button ⑤ and keep it pressed until the **LED** ① alternately flashes blue and red.

▶ Press the **Bluetooth** button ⑥ for at least 5 seconds until the settings of the headset are reset.

Specifications

Transducer principle	dynamic, closed
Ear coupling	circumaural
Frequency response	15 – 22,000 Hz
Nominal impedance active/passive	590/100 Ω
Sound pressure level at 1 kHz and 1 Volt	107 dB SPL
THD at 1 kHz	< 0.1%
Audio connection	3.5 mm stereo jack socket
Audio adapter	¼" (6.35 mm) stereo jack plug
In-flight adapter	3.5 mm double mono jack plug
Cable length	
Audio cable	1.4 m
Charging cable	0.8 m
Weight	179 g
BA 370 PX battery pack	3.7 V; 250 mAh Lithium-Polymer
Charging time	3 hrs
Operating time	8 hrs/10 hrs/20 hrs
Operating temperature range	0°C to +40°C
Storage temperature range	-10°C to +70°C
Passive noise attenuation	25 dB
NoiseGard	
active noise compensation	23 dB

PSAI05R-050Q or SIL SSA-4P 5050F mains unit

Nominal input voltage	110 – 240 V~
Nominal input current	max. 0.2 A
Mains frequency	50 – 60 Hz
Nominal output voltage	5 V ---
Nominal output current	SIL SSA-4P 5050F: max. 0.5 A PSAI05R-050Q: max. 1 A
Operating temperature range	0°C to +45°C
Storage temperature range	-40°C to +85°C
Relative humidity	20 to 90% RH
Weight	approx. 179 g

Bluetooth

Bluetooth	version 2.1 + EDR
Range	up to 10 m
Transmission frequency	2.4 GHz
Transmission power	8 dBm
Profiles	HSP, HFP, A2DP, AVRCP
Codec	SBC, apt-X



Valuable information on MM 550-X

SRS WOW HD

Remarkable enhancement for mono and stereo playback

SRS WOW HD improves the dynamic audio performance of compressed and uncompressed audio by expanding the size of the audio image and creating a deep, rich bass response. The patented techniques in SRS WOW HD widen the horizontal sound field and raise the vertical sound image, retrieving information lost in the mixing process to create a more natural audio experience. SRS WOW HD also shapes a maximized bass response using sculpted filters and driver physics to go beyond the low-frequency limitations of speakers and headphones. SRS WOW HD also adds Definition™ Control, for realistic clarity, and the new Center Control, for dynamic extraction and positioning of dialog.

Immersive 3D audio

SRS WOW HD adjusts the space of the stereo image and eliminates the narrow stereo sweet spot and creates an immersive stereo image from mono and stereo source material. It also restores audio realism which is often masked by traditional recording and playback techniques.

Center Control

SRS WOW HD adjusts the mix of the center information into the stereo image. It works in tandem with the space control to create the perfect balance, acting as a “zoom” lens for sound. It can bring content to the forefront to dominate the mix or fade it backward, virtually eliminating the content all together.

Optimal headphone listening

SRS WOW HD includes techniques based on patented HRTFs to deliver a natural, non-fatiguing headphone listening experience by placing the perception of the stereo sound image outside of one’s head making it more realistic and immersive.

Elevated sound image

SRS WOW HD adjusts the horizontal plane of the audio image from non-optimally placed speakers placing it at an appropriate listening level.

Definition Control

SRS WOW HD delivers a livelier, more brilliant sound. The purified sound can be heard in musical vocals, high-frequency instruments, and exposes details of ambient sound present in the audio source.

Bigger bass

SRS WOW HD includes psychoacoustic bass enhancement techniques which enhance the perception of low bass frequencies from speakers and headphones which, under normal conditions, can not produce these frequencies due to the inherent low frequency cut off and driver size limitations.

Audio level management

SRS WOW HD includes an audio level management system which monitors the output levels of the entire product audio system and manages the level dynamically to prevent sudden audio clipping.

Features of SRS WOW HD

- Stereo enhancement which improves dynamic audio performance
- Sculpted bass response for maximum thump on small speakers
- More natural audio with a wider sound field and raised sound image
- High-definition control for realistic clarity
- Center Control for dynamic extraction and positioning of dialog

apt-X audio coding

Outstanding audio quality

apt-X technology is what wireless audio has been waiting for. With apt-X audio coding, you can be assured of crisp, pure and full stereo sound. It allows you to not only hear, but experience and feel the audio as it was intended. Utilizing apt-X, **Bluetooth** can now offer wireless audio quality that is indistinguishable from the highest quality wired connection.

Professional grade sound

Until now, apt-X has been the best-kept secret of the professional audio industry. From major public broadcasters to film production studios, apt-X is used throughout the world to transmit high quality digital audio from A to Z in real-time. It was developed to meet the exacting standards of musicians and audio engineers who love the exceptional dynamic range and high fidelity it provides.

Now available on selected consumer devices, the technology ensures that music lovers everywhere can stream the rich listening experience that only apt-X can deliver.

Revolutionizing Bluetooth listening

Bluetooth technology has revolutionized our communications and lifestyle by eliminating troublesome wires and letting us get on with life “on the move”. Listening to a mobile phone conversation on a **Bluetooth** ear-piece sounds just fine but when it comes to delivering full stereo sound, a little extra help is required. apt-X works within **Bluetooth** to deliver CD quality audio, ensuring you are getting the most from your wireless listening experience.

In order to deliver two-channel digital sound within the **Bluetooth** A2DP profile, audio compression is necessary. While traditional audio compression technologies struggle to provide full-bandwidth, high-fidelity audio over **Bluetooth**, apt-X works to ensure you enjoy the fullest, richest sound your music collection has to offer.

apt-X legacy

If you have ever been to the movies or listened to the radio then chances are you’ll already have heard apt-X in action. Over 20,000 radio stations across the world and thousands of cutting-edge film studios rely on apt-X for high quality audio delivery.

The digital compression technology now known as apt-X was originally developed in Queen’s University, Belfast, Northern Ireland. The technology was first brought to market for radio automation applications to store CD quality audio on computer hard drives for direct playout during radio shows, hence automating the process of the disc jockey.

The acclaim the technology received led to further research and development and throughout the 1990s the technology was used by Broadcast and Post-production studios worldwide to deliver high-fidelity, low latency audio in situations where bandwidth was limited. The same core principles that have earned apt-X worldwide acclaim in the Broadcast and Post-Production markets make it the perfect solution for delivering high quality audio on wireless devices. apt-X is leading the way in bringing pro-audio quality to the discerning consumer.

apt-X key features:

- Blind listening tests with industry reference audiences have shown that apt-X over **Bluetooth** is indistinguishable from audio delivered over wired technology. Unlike psychoacoustic-based technologies such as MP3 or AAC, apt-X can be used to transport audio without degrading the audio quality. With MPEG/AAC compression, the encoding process is destructive and content perceived as “irrelevant” is discarded. apt-X’s transparent, non-destructive approach ensures that every frequency present in the original signal is preserved in the encoded and decoded signal.
- Dynamic range of >92 dB for 16 bit audio and >120 dB for 24 bit audio.
- The overall framework of apt-X ensures a high degree of resilience to random bit errors, with the bit error response well matched to the auditory response of the human ear. apt-X employs connection and synchronization techniques to ensure a robust connection and enable delivery of audio even under stressful conditions.
- Shortest processing delay of any professional audio compression technology. Many current wireless devices suffer from unwanted delays which cause lip-sync issues, apt-X can enable real-time delivery of wireless audio ensuring seamless integration when used with video devices.
- apt-X encoded audio fits neatly within the available bandwidth of wireless transmission standards to offer an efficient solution for bandwidth-restricted connections.

Manufacturer Declarations

Warranty

Sennheiser electronic GmbH & Co. KG gives a warranty of 24 months on this product. For the current warranty conditions, please visit our website at www.sennheiser.com or contact your Sennheiser partner.

In compliance with the following requirements

- RoHS Directive (2002/95/EC)
- WEEE Directive (2002/96/EC)



Please dispose of this product by taking it to your local collection point or recycling center for such equipment.

- Battery Directive (2006/66/EC)



The supplied standard/rechargeable batteries can be recycled. Please dispose of them as special waste or return them to your specialist dealer. In order to protect the environment, only dispose of exhausted batteries.

CE Conformity

- R&TTE Directive (1999/5/EC)
- EMC Directive (2004/108/EC)
- Low Voltage Directive (2006/95/EC)
- ErP directive (2009/125/EC)

The declaration is available at www.sennheiser.com. Before putting the product into operation, please observe the respective country-specific regulations!

Trademarks

Sennheiser and NoiseGard™ are registered trademarks of Sennheiser electronic GmbH & Co. KG.

The **Bluetooth**® word mark and logos are registered trademarks owned by Bluetooth SIG, Inc. and any use of such marks by Sennheiser electronics GmbH & Co. KG is under license.

iPhone® and iPod® are registered trademarks of Apple Inc, registered in the U.S. and other countries.

SRS WOW HD™ is a registered trademark of SRS Labs, Inc.

Definition™ Control is a registered trademark of SRS Labs, Inc.

apt-X is a registered trademark of CSR plc.



Sennheiser electronic GmbH & Co. KG

Am Labor 1, 30900 Wedemark, Germany
www.sennheiser.com

Publ. 12/11, 546145/A01