

Wrist Blood Pressure Monitor

Model RS3 Instruction Manual

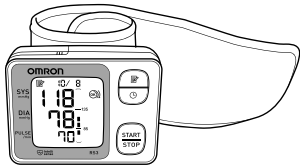

IM-HEM-6130-E-02-01/2013
5338830-7B

Introduction

Thank you for purchasing the OMRON RS3 Wrist Blood Pressure Monitor.

The OMRON RS3 is a compact and easy to use blood pressure monitor, operating on the oscillometric principle. It measures your blood pressure and pulse rate simply and quickly. For comfortable controlled inflation without the need of pressure pre-setting or re-inflation the device uses its advanced "IntelliSense" technology.

Intended Use

This product is designed to measure the blood pressure and pulse rate of people within the range of the designated wrist cuff, following the instructions in this instruction manual.

It is mainly designed for general household use. Please read the Important Safety Information in this instruction manual before using the unit.

Please read this instruction manual thoroughly before using the unit.

Please keep for future reference.

For specific information about your own blood pressure, CONSULT YOUR DOCTOR.

Important Safety Information

Consult your doctor prior to using in pregnancy or if diagnosed with arrhythmia or arteriosclerosis.

Please read this section carefully before using the unit.

Warning:

- Indicates a potentially hazardous situation which, if not avoided, could result in death or serious injury.

(General Usage)

- Always consult your doctor. Self-diagnosis of measurement results and self-treatment are dangerous.
- People with severe blood flow problems, or blood disorders, should consult a doctor before using the unit, as cuff inflation can cause internal bleeding.

(Battery Usage)

- If battery fluid should get in your eyes, immediately rinse with plenty of clean water. Consult a doctor immediately.

Caution:

- Indicates a potentially hazardous situation which, if not avoided, may result in minor or moderate injury to the user or patient or damage to the equipment or other property.

(General Usage)

- Do not leave the unit unattended with infants or persons who cannot express their consent.
- Do not use the unit for any purpose other than measuring blood pressure.
- Do not use a mobile phone or other devices that emit electromagnetic fields, near the unit. This may result in incorrect operation of the unit.
- Do not disassemble the unit or wrist cuff.
- Do not operate the unit in a moving vehicle (car, airplane).

(Battery Usage)

- If battery fluid should get on your skin or clothing, immediately rinse with plenty of clean water.
- Use only two "AAA" alkaline (LR03) batteries with this unit.
- Do not insert the batteries with their polarities incorrectly aligned.
- Replace old batteries with new ones immediately. Replace both batteries at the same time.
- Remove the batteries if the unit will not be used for three months or more.
- Do not use new and used batteries together.

General Precautions

- Do not apply strong shocks and vibrations to or drop the unit.
- Do not take measurements after bathing, drinking alcohol or caffeine, smoking, exercising or eating.
- Do not inflate the wrist cuff when it is not wrapped around your wrist.
- Read and follow the "Important information regarding Electro Magnetic Compatibility (EMC)" in the Technical Data Section.
- Read and follow the "Correct Disposal of This Product" in the Technical Data Section when disposing of the device and any used accessories or optional parts.

1. Overview

Main unit:

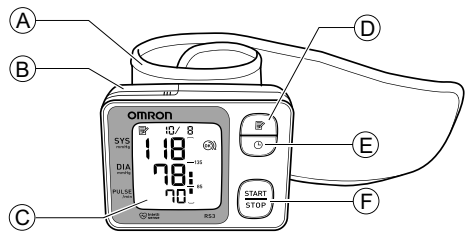

- A. Wrist cuff
- B. Battery compartment
- C. Display
- D. Memory (M) button
- E. Date/Time setting (⌚) button
- F. START/STOP button

Display:

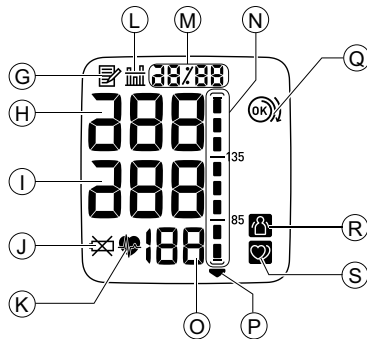

- G. Memory symbol
- H. Systolic blood pressure
- I. Diastolic blood pressure
- J. Battery low symbol
- K. Heartbeat symbol (Flashes during measurement)
- L. Average value symbol
- M. Date/Time display
- N. Blood pressure level indicator
- O. Pulse display and Memory number
- P. Deflation symbol
- Q. Cuff wrapping guide
- R. Movement error symbol
- S. Irregular heartbeat symbol

2. Preparation

2.1 Installing/Replacing the Batteries

1. Remove the battery cover.



2. Insert two 1.5V "AAA" alkaline (LR03) batteries as indicated in the battery compartment and then replace the battery cover.

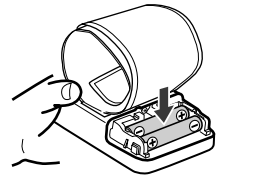

Notes:

- If the battery low symbol (⊖) appears on the display, turn off the unit then replace both batteries at the same time.
- The measurement values continue to be stored in memory even after the batteries are replaced.

Disposal of used batteries should be carried out in accordance with the national regulations for the disposal of batteries.

2.2 Setting the Date and Time

1. Press and hold the ⌚ button until the year flashes on the display.

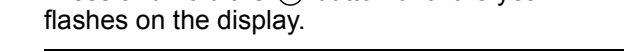

2. Set the monitor to the correct date and time before taking a measurement for the first time.

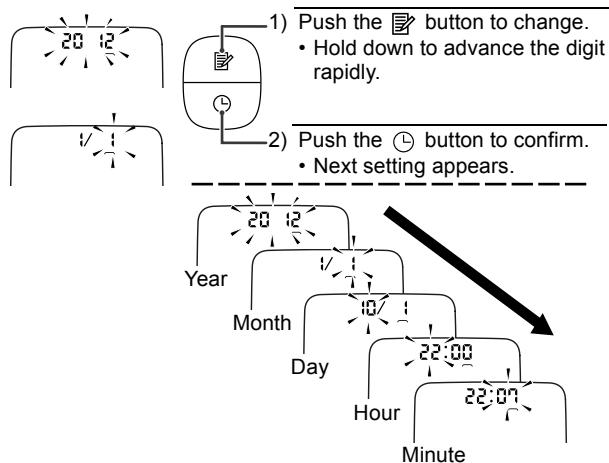

3. Press the START/STOP button to store the setting.

Notes:

- If the batteries have been removed, the date and time setting will need to be reset.
- If the date and time are not set, "-:--" appears during or after measurement.

3. Using the Unit

3.1 Applying the Wrist Cuff

Do not apply over clothing.

1. Place the wrist cuff over your wrist.

Your palm should face upward.

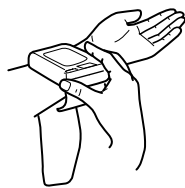

2. Wrap the wrist cuff around your wrist.

Wrap the wrist cuff securely around the wrist for taking accurate measurements.

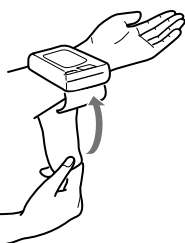

Make sure that the wrist cuff does not cover the protruding part of the wrist bone (ulna) on the outside of the wrist.

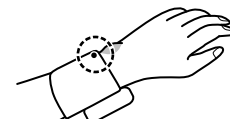

Note: You can take a measurement on either your left or right wrist.



3.2 How to Sit Correctly

To take a measurement, you need to be relaxed and comfortably seated, under comfortable room temperature. No bathing, drinking alcohol or caffeine, smoking, exercising or eating 30 minutes before taking a measurement.

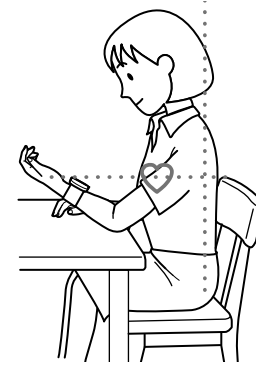

- Sit on a chair with your feet flat on the floor.
- Sit upright with your back straight.
- The cuff should be at the same level as your heart.

- Relax your wrist and hand. Do not bend your wrist back, clench your fist, or bend your wrist forward.

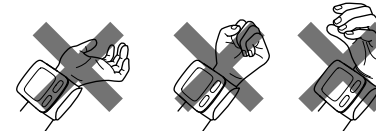

3.3 Taking a Reading

Notes:

- To cancel a measurement, press the START/STOP button at any time during measurement.
- Remain still while taking a measurement.

1. Press the START/STOP button.

All the symbols appear on the display. The wrist cuff will start to inflate automatically.

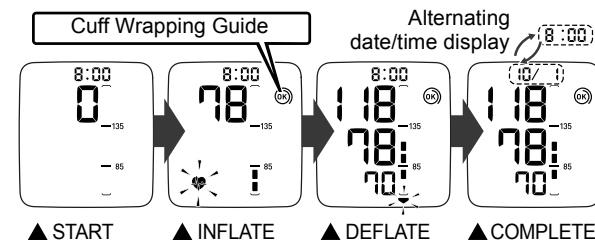

Cuff Wrapping Guide

The Cuff Wrapping Guide is a unique feature that indicates if the cuff is not wrapped tightly enough around the wrist. Even when the (M) is displayed, a blood pressure reading will be taken.

Note: This reading is NOT reliable due to the incorrect wrapping of the cuff. Please wrap the cuff again, taking care to wrap it correctly and take the measurement again. When the (M) is displayed, the cuff is correctly wrapped tightly enough on the wrist and the reading is accurate and reliable.

2. Undo the wrist cuff and remove the unit.

3. Press the START/STOP button to turn off the monitor.

The monitor automatically stores the measurement in its memory. It will automatically turn off after two minutes.

Important:

- Recent research suggests that the following values can be used as a guide to high blood pressure for measurements taken at home.

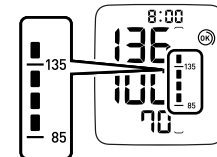

Systolic Blood Pressure	Above 135 mmHg
Diastolic Blood Pressure	Above 85 mmHg

This criteria is for home blood pressure measurement.

- Your blood pressure monitor includes an irregular heartbeat feature. Irregular heartbeats can influence the results of the measurement. The irregular heartbeat algorithm automatically determines if the measurement is usable or needs to be repeated. If the measurement results are affected by irregular heartbeats but the result is valid, the result is shown together with the irregular heartbeat symbol (M).

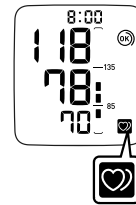

If the irregular heartbeats cause the measurement to be invalid, no result is shown. If the irregular heartbeat symbol (M) is shown after you have taken a measurement, repeat the measurement. If the irregular heartbeat symbol (M) is shown frequently, please make your doctor aware of it.

- If you move during measurement, the movement error symbol (R) will appear on the display. Keep still and repeat the measurement.

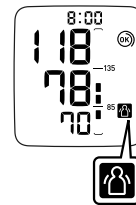

Notes:

- Wait 2 - 3 minutes before taking another blood pressure measurement. Waiting between readings allows the arteries to return to the condition prior to taking the blood pressure measurement.
- The blood pressure can differ between the right arm and the left arm, and therefore also the measured blood pressure values can be different. OMRON recommends to always use the same arm for measurement. If the values between the two arms differ substantially, please check with your physician which arm to use for your measurement.

Warning:

Self-diagnosis of measured results and treatment are dangerous. Please follow the instructions of your doctor.

3.4 Using the Memory Function

The unit automatically stores up to 60 sets of measurement values (blood pressure and pulse rate).

It can also calculate an average reading based on the measurements from the last three readings taken within 10 minutes. If there are only two readings in memory for that period, the average will be based on two readings. If there is one reading in memory for that period, the average will be based on one reading.

Notes:

- If the memory is full, the monitor will delete the oldest readings.
- When viewing the reading taken without setting the date and time, “-:-” is displayed instead of the date and time.

To View the Average Value

Press the Memory button.

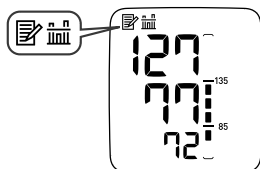

Note: If there are no measurements results stored in the memory, the screen to the right is displayed.

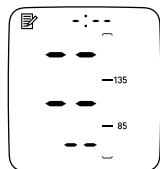

To View the Readings Stored in Memory

1. Press the Memory button, while the average value is displayed.

The Memory number appears for a second before the pulse rate is displayed. The newest set is numbered “1”.

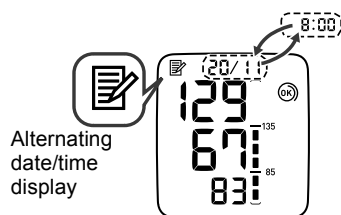

2. Press the Memory button repeatedly to view the readings stored in memory.

To Delete All the Values Stored in Memory

When the memory symbol (M) appears, first press the Memory button. Then while holding it down, press the START/STOP button simultaneously for about 2 - 3 seconds.

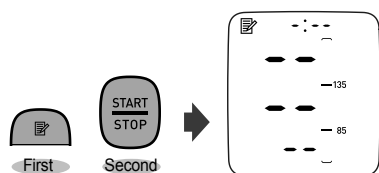

Note: You cannot partially delete the stored readings.

4. Troubleshooting and Maintenance

4.1 The Icons and Error Messages

Error Display	Cause	Remedy
	Irregular heartbeats are detected.	Remove the wrist cuff. Wait 2 - 3 minutes and then take another measurement. Repeat the steps in section 3.3. If this error continues to appear, contact your doctor.
	Movement during measurement.	Carefully read and repeat the steps in section 3.3.
	The batteries are low.	You should replace them with new ones ahead of time. Refer to section 2.1.
	The batteries are exhausted.	You should replace them with new ones at once. Refer to section 2.1.
E1	Wrist cuff not applied correctly.	Apply the wrist cuff correctly. Refer to section 3.1.
E3	Movement during measurement.	Repeat Measurement while remaining still and refraining from talking during the measurement. Refer to section 3.3.
E4		
E5	Wrist cuff not applied correctly, or movement during measurement.	Apply the wrist cuff correctly and repeat measurement while remaining still and refraining from talking during the measurement. Refer to section 3.1 and 3.3.
Er	Device error.	Contact your OMRON retail outlet or distributor.

Note: The irregular heartbeat symbol (M) may also be displayed with error messages.

4.2 Troubleshooting

Problem	Cause	Remedy
The reading is extremely low (or high).	The wrist cuff is not at heart level.	Measure while in the correct posture. Refer to section 3.2.
	The cuff is not wrapped snugly around the wrist.	Wrap the cuff correctly. Refer to section 3.1.
	The arms and shoulders are tense.	Relax and try taking the measurement again. Refer to section 3.3.
	Movement or talking during measurement.	Remain still and do not talk during Measurement. Refer to section 3.3.
Wrist cuff pressure does not rise.	Air is leaking from the wrist cuff.	Consult your OMRON retail outlet or distributor.
Wrist cuff deflates too soon.	The wrist cuff is loose.	Apply the cuff correctly so that it is firmly wrapped around the wrist. Refer to section 3.1.
The blood pressure is different each time. The reading is extremely low (or high).		Blood pressure readings constantly vary with time of day and how relaxed you are. Take several deep breaths and try to remain relaxed before taking a measurement.
The unit loses power during measurement.	The batteries are exhausted.	Replace the batteries with new ones. Refer to section 2.1.
Nothing happens when you press the buttons.	The batteries have been inserted incorrectly.	Insert the batteries with the correct (+/-) polarity. Refer to section 2.1.
Other problems.		<ul style="list-style-type: none"> • Press the START/STOP button and repeat measurement. • If the problem continues, try replacing the batteries with new ones. If this still does not solve the problem, contact your OMRON retail outlet or distributor.

4.3 Maintenance

To protect your unit from damage, please observe the following:

- Do not subject the main unit and the cuff to extreme temperatures, humidity, moisture or direct sunlight.
- Do not disassemble the unit.
- Do not subject the unit to strong shocks or vibrations (for example, dropping the unit on the floor).
- Do not use volatile liquids to clean the main unit.
- Do not wash the cuff or immerse it in water.
- Do not use petrol, thinners or similar solvents to clean the cuff.
- Do not carry out repairs of any kind yourself. If a defect occurs, consult your OMRON retail outlet or distributor as mentioned on the packaging.

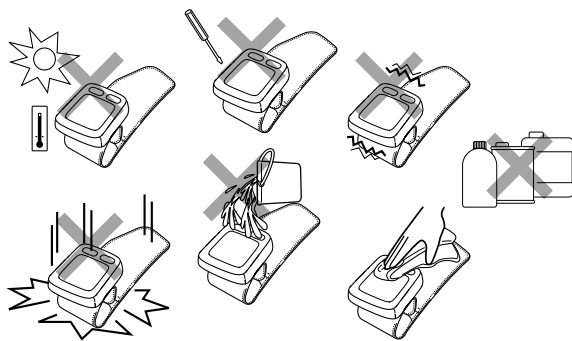

- The unit should be cleaned with a soft, dry cloth.
- Use a soft, moistened cloth and soap to clean the cuff.
- Keep the unit in its storage case when not in use.
- Fold the cuff into the storage case.

Do not store the unit in the following situations:

- If the unit is wet.
- Locations exposed to extreme temperatures, humidity, direct sunlight, dust or corrosive vapours.
- Locations exposed to vibrations, shocks or where it will be at an angle.

Calibration and Service

- The accuracy of this blood pressure monitor has been carefully tested and is designed for a long service life.
- It is generally recommended to have the unit inspected every two years to ensure correct functioning and accuracy. Please consult your authorised OMRON dealer or the OMRON Customer Service at the address given on the packaging or attached literature.

5. Technical Data

Product Description	Wrist Blood Pressure Monitor
Model	OMRON RS3 (HEM-6130-E)
Display	LCD Digital Display
Measurement Method	Oscillometric method
Measurement Range	Pressure: 0 to 299 mmHg Pulse: 40 to 180/min.
Accuracy	Pressure: ±3 mmHg Pulse: ±5% of display reading
Inflation	Automatic inflation by pump
Deflation	Automatic rapid deflation
Memory	60 Measurements
Power Source	2 “AAA” alkaline (LR03) batteries 1.5V
Battery Life	Approx. 300 measurements with new alkaline batteries at a room temperature of 23°C
Applied Part	= Type B
Protection Against Electric Shock	Internally powered ME equipment
Operating temperature/ Humidity	+10 to +40°C / Maximum: 30 to 85% RH
Storage temperature/ Humidity	-20 to +60°C / Maximum: 10 to 95% RH / 700 to 1060hPa
Console Weight	Approximately 101g without batteries
Outer Dimensions	Approximately 78 (w) mm x 60 (h) mm x 21 (d) mm (without the wrist cuff)
Measurable circumference	Approximately 13.5 to 21.5 cm
Cuff Material	Nylon and polyester
Package Content	Main unit, storage case, battery set, instruction manual, guarantee card

Note: Subject to technical modification without prior notice.

CE 0197

- This device fulfils the provisions of EC directive 93/42/EEC (Medical Device Directive).
- This blood pressure monitor is designed according to the European Standard EN1060, Non-invasive sphygmomanometers Part 1: General Requirements and Part 3: Supplementary requirements for electromechanical blood pressure measuring systems.
- This OMRON product is produced under the strict quality system of OMRON HEALTHCARE Co. Ltd., Japan. The Core component for OMRON blood pressure monitors, which is the Pressure Sensor, is produced in Japan.

Important information regarding Electro Magnetic Compatibility (EMC)

With the increased number of electronic devices such as PC's and mobile (cellular) telephones, medical devices in use may be susceptible to electromagnetic interference from other devices. Electromagnetic interference may result in incorrect operation of the medical device and create a potentially unsafe situation. Medical devices should also not interfere with other devices.

In order to regulate the requirements for EMC (Electro Magnetic Compatibility) with the aim to prevent unsafe product situations, the EN60601-1-2:2007 standard has been implemented. This standard defines the levels of immunity to electromagnetic interferences as well as maximum levels of electromagnetic emissions for medical devices.

This medical device manufactured by OMRON HEALTHCARE conforms to this EN60601-1-2:2007 standard for both immunity and emissions.

Nevertheless, special precautions need to be observed:

- Do not use mobile (cellular) telephones and other devices, which generate strong electrical or electromagnetic fields, near the medical device. This may result in incorrect operation of the unit and create a potentially unsafe situation. Recommendation is to keep a minimum distance of 7 m. Verify correct operation of the device in case the distance is shorter.

Further documentation in accordance with EN60601-1-2:2007 is available at OMRON HEALTHCARE EUROPE at the address mentioned in this instruction manual. Documentation is also available at www.omron-healthcare.com.

Correct Disposal of This Product (Waste Electrical & Electronic Equipment)

This marking shown on the product or its literature, indicates that it should not be disposed of, with other household wastes at the end of its working life.

To prevent possible harm to the environment or human health from uncontrolled waste disposal, please separate this product from other types of wastes and recycle it responsibly to promote the sustainable reuse of material resources.

Household users should contact either the retailer where they purchased this product, or their local government office, for details of where and how they can return this item for environmentally safe recycling.

Business users should contact their supplier and check the terms and conditions of the purchase contract. This product should not be mixed with other commercial wastes for disposal.

Manufacturer	OMRON HEALTHCARE Co., Ltd. 53, Kunotsubo, Terado-cho, Muko, Kyoto, 617-0002 JAPAN
EU-representative	OMRON HEALTHCARE EUROPE B.V. Scorpius 33, 2132 LR Hoofddorp THE NETHERLANDS www.omron-healthcare.com
Production facility	OMRON (DALIAN) CO., LTD. Dalian, CHINA
Subsidiary	OMRON HEALTHCARE UK LTD. Opal Drive, Fox Milne, Milton Keynes, MK15 0DG U.K. OMRON MEDIZINTECHNIK HANDELSGESELLSCHAFT mbH John-Deere-Str. 81a, 68163 Mannheim, GERMANY www.omron-medizintechnik.de OMRON SANTÉ FRANCE SAS 14, rue de Lisbonne, 93561 Rosny-sous-Bois Cedex, FRANCE

Made in China