



















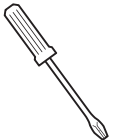

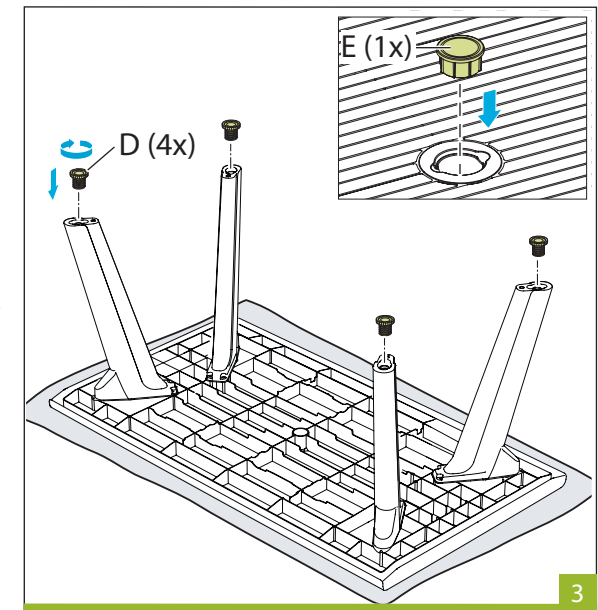
	NEN 581  	
	  	
	   	
	 	
	  	
	 	
	 	
 		

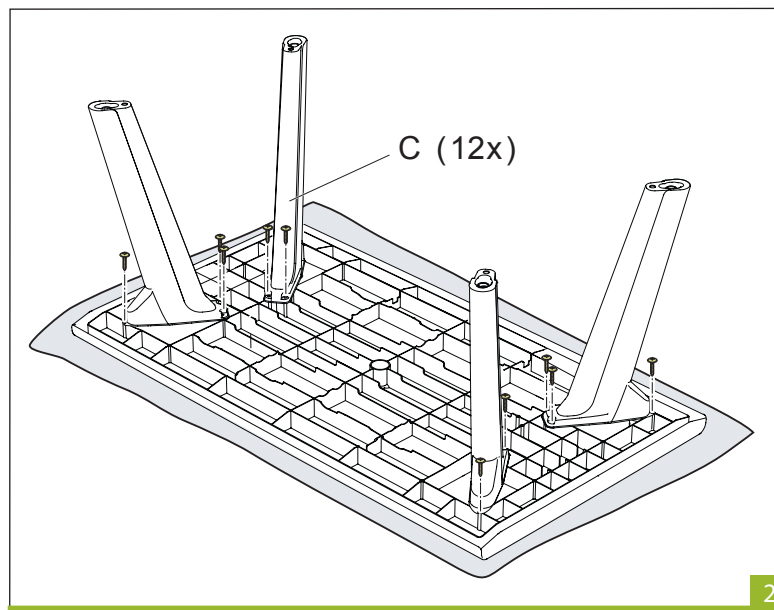
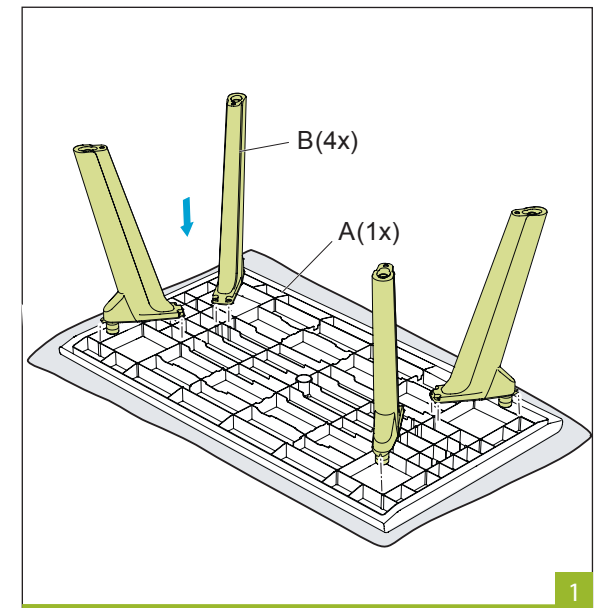
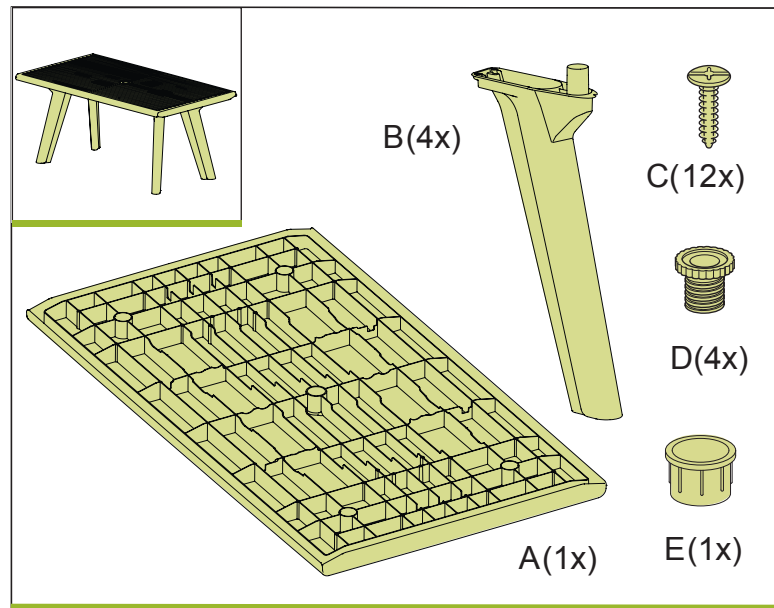

"DANTE TABLE" / 533128 / 1400-1.1401

Allibert Netherlands B.V.  
 Jardin Netherlands B.V.  
 Keter Plastic LTD  
 Keter (UK) LTD

Ericssonstraat 17 Rijen, Postbus 224, 5120 AE Rijen, The Netherlands, Tel: 31 161 227 002  
 Ericssonstraat 17 Rijen, Postbus 224, 5120 AE Rijen, The Netherlands, Tel: 31 161 227 002  
 2 Sapir St. Industrial Area, Herzelia 46852, P.O. Box 12558 Israel, Tel: 972 995 86 142  
 Unit 4. Woodgate Business Park, Claggate Lane, Birmingham B32 3DB, England, Tel: 44 121 422 66 33, Fax: 44 121 422 08 08